

Drainage is ever more called upon to go beyond basic waste water disposal. Vertical living and increased living standards have made acoustic comfort increasingly more important. It requires a solution beyond what has been traditionally available.

This is specialist drainage.

In this Specification Manual you will find the complete dBlue Acoustic Soil & Waste product range. It is the latest addition to the Akatherm range of Specialist Drainage Systems.

The Akatherm dBlue system is made from a state-of-the-art combination of plastic and sound absorbing mineral filler (PP-MD) to maximise absorbance of sound. It offers a unique combination of acoustic performance, weight, resistance and mechanical strength.

In addition to pipes, fittings, connection fittings, transition fittings and traps, you will find all required information on acoustic performance, planning and design, installation, bracketing and relevant standards and approvals.

This manual also comprises substantial technical details of the material properties and chemical resistance of the Akatherm dBlue system. It will assist you with the application, design and installation.

Enjoy Silence with the Akatherm dBlue Acoustic Soil & Waste System.

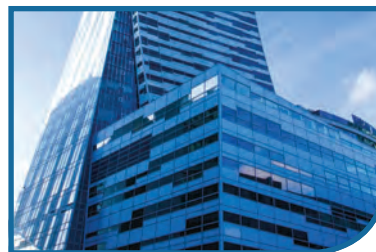

Information and safety recommendations

Applicability

This Specification Manual is applicable for installations with under slab soil & waste systems.

Validity

This Specification Manual is valid from February 2018. With the appearance of this manual previous manuals are no longer valid. The actual technical documentation can be downloaded at www.akatherm.com.

This document is protected by copyright. The resulting rights, in particular those of translation, reprinting, reuse of illustrations, the radio broadcasting, reproduction by photo-mechanical or similar means, and storage in data processing systems, are reserved.

This Specification Manual is produced with extreme care. All measurements and weights are approximate and errors and changes reserved. Akatherm BV does not accept any liability for damage caused by not or incorrect mentioned data in this manual.

Important information and pictograms

This manual contains pictograms to emphasize important or beneficial information.

 Important information to take into account

 Consult the Akatherm dBlue Sales Office

 Benefit

Disclaimer

Follow all applicable national and international assembly, installation, accident prevention and safety regulations. Furthermore follow the information in this Specification Manual during the installation of drainage systems.

Also follow the applicable laws, standards, guidelines, regulations and instructions for environmental protection, professional associations and the local utility companies.

Applications not covered in this Specification Manual (special applications) require consultation with our technical department. For specific advice consult the Akatherm dBlue Sales Office.

The planning and installation instructions are directly related to the respective Akatherm dBlue products. The reference to standards or regulations is on a general level. Be aware of the current status of guidelines, standards and regulations. Other standards, regulations and guidelines regarding the planning, installation and operation of drainage or building systems need to be taken into account also and are not part of this Specification Manual.

 Please check for your safety and for the proper application of our products at regular intervals if your present Specification Manual has been replaced by a new version. The issue date is always mentioned on the cover. The valid technical information can be obtained at your Akatherm dBlue wholesaler, the Akatherm Export Sales Office and be downloaded at www.akatherm.com.

Safety and operating instructions

- Read the safety and operating instructions completely for your own safety and the safety of others before the start of installation
- Store these instructions and keep them available
- If the safety instructions or installation instructions are unclear, please contact the Akatherm dBlue Sales Office

General precautions

- Keep your work area clean and free of obstructing objects
- Provide adequate lighting of your work area
- Keep unauthorized persons away of tools and the work area, especially at renovations in inhabited areas
- Use only Akatherm dBlue system components. The use of non-system components can lead to leakage or other problems

During assembly

- Always read and follow the operating instructions of the used tool
- Improper use of tools can cause severe cuts, bruising or dismemberment
- Improper use of tools can damage components and cause leaks
- Pipe cutters have a sharp blade. Store and handle without risk of injury
- Note the safety distance between your hand and cutting tool when cutting the pipes
- Never grab the cutting zone of the tool or moving parts during the cutting process

dBlue acoustic soil & waste system

Preface	1
Information and safety recommendations	2
Table of contents	3
1. System information	
1.1 Intended use	5
1.2 Applications	5
1.3 Triple-layer pipe	6
1.4 Uniform fittings	6
1.5 Acoustic brackets	6
1.6 Sound insulation	7
1.7 Packaging, transport and storage	7
1.8 Marking	8
1.9 Recycling	8
2. Approvals, standards and quality	
2.1 Approvals	9
2.2 Standards	9
2.3 Quality management	10
2.4 Warranty	10
2.5 Akatherm and Aliaxis	10
3. System and material properties	
3.1 Technical specifications	11
3.2 Properties and benefits	12
4. Sound insulation	
4.1 Noise in a soil & waste system	13
4.2 Sound insulation requirements	13
4.3 Sound reduction with Akatherm dBlue	14
4.4 Acoustic testing	14
5. Planning and design	
5.1 Relevant standards	16
5.2 Ceiling penetrations	17
5.3 Passive fire protection	17
5.4 Transition from downpipe to collector pipe	19
5.5 Horizontal change of direction	19
5.6 Inspection and maintenance	19
5.7 Transitions to other materials	20
5.8 Bathroom installation	21
5.9 Kitchen installation	21
5.10 dBlue high-rise design	22
5.11 Embedding Akatherm dBlue in concrete	23
5.12 Underground installation of dBlue	23
5.11 Stormwater drainage and condensation	24
5.12 Professional kitchens	24
5.13 Fire protection	24
6. Fixing system	
6.1 Bracketing plan in the vertical stack	25
6.2 Bracketing plan in horizontal pipes	26
6.3 Support bracing	26

7. Installation	
7.1 Shortening and chamfering	28
7.2 Jointing pipes and fittings	29
7.3 Fixing system	29
7.4 Transitions to other materials	30
7.5 dBlue Stack-aerator	31
7.6 Floor waste gully	31
7.7 Disconnecter trap and 4-way riser	32
7.8 Embedding Akatherm dBlue in concrete	33
7.9 Fire protection	33
7.10 Using pipe remainders without a socket	34
7.11 Additions to an existing system	34
7.12 Testing	35
8 Product range	
8.1 Dimensions	38
8.2 Abbreviations	38
Pipes	
Pipe with socket	39
Pipe plain-end	40
Fittings	
Sockets	41
Reducers	42
Elbows	43
Swept bend	44
Branches	45
Socket plug	49
Expansion socket	50
Traps	
Floor waste gully	51
Four way riser	51
Adjustable disconnecter trap	52
P-trap	52
Transition fittings	
Cast iron transition	53
PVC to dBlue transition	53
Other materials to dBlue transition	53
Fixing material	
Acoustic brackets	54
Socket securing clip	55
Socket retainer for testing	55
Tools & accessories	
Tools & accessories	56
Appendix A	
Chemical resistance	58
Index	60
Article list	61

1 System information

1.1 Intended use

Akatherm dBlue is an innovative noise-attenuated soil & waste drainage system, designed to be installed in accordance with EN12056. It is suitable for use in multi-occupancy applications as well as hospitals and hotels and other commercial applications, where reduced noise levels are preferred.

Akatherm dBlue is available in nominal diameters DN40 to DN200 with a full range of socketed pipes, a comprehensive range of fittings including brackets, transition adaptors as well as the Stack-Aerator high-rise solution for single stack downpipes.

- +** The system has the following features:
- Complete rubber ring joint system with excellent sound-insulation properties
 - Made from a state-of-the-art combination of polypropylene and sound absorbing mineral filler (PP-MD) for airborne noise reduction
 - A triple layer pipe which is rigid, noise-attenuated with a smooth bore that resists incrustation and blockages
 - dBlue metal brackets with rubber lining dampen vibrations and reduce Structure borne noise
 - Fast and easy installation without special equipment
 - Robust fittings that resist on-site- and transit damage
 - Installation inside the building and embedded in concrete (wrapped connections)
 - Stack-Aerator high-rise solution for single stack downpipes
 - Sustainable system which is 100% recyclable



Illustration 1.1

1.2 Applications

Akatherm dBlue is designed to be installed in accordance with EN12056. Thereby, Akatherm dBlue meets the requirements for use in residential and commercial buildings.

Residential buildings

Its excellent sound insulation properties result in a high noise reduction without insulation and is an ideal and cost effective alternative for insulated PVC in single and multi-occupancy buildings.

Commercial buildings

Akatherm dBlue is an innovative and professional soil & waste drainage system and its many distinct features and high quality make it suited for a wide range of commercial applications like:

- Hotels, spas, luxury resorts
- Multi occupancy buildings
- High-rise buildings
- Multi-storey buildings
- Concert halls, museums and cinemas
- Hospitals
- Office buildings
- Professional kitchens

Akatherm dBlue is designed for noise reduction and allows you to enjoy urban living with increased living standards.

- +** **No acoustic insulation required**
- Akatherm dBlue does not require additional acoustic insulation, offering many significant advantages:
- No insulation material required
 - No insulation installation time
 - Less scheduling of companies
 - Consistent acoustic results during installation lifetime
 - No unverified insulation materials
 - Faster and easier inspection
 - Faster and easier maintenance

Application parameters

The pipes, fittings and seals can be used continuously at 90°C and up to 95°C for brief periods. They are suitable for the drainage of chemically aggressive waste water with a pH value of 2 (acidic) to 12 (basic).

Behaviour in fire corresponds to B2 normal combustibility according to DIN 4102 and E according to EN 13501-1.

Akatherm dBlue is suited for installation down to -10°C.

For installation in applications not listed in this manual or with chemicals not listed in the chemical resistance list found in Appendix A of this manual, please contact your local office for further advice.

Where not to use

Although Akatherm dBlue is very versatile, it is not a true chemical drainage system and is not recommended for industrial chemical drainage and laboratory drainage.

The preferred solution for these applications is a homogenous welded PE or PP system using butt-welding and electrofusion technology like Akatherm HDPE. See www.akatherm.com.

System information

1.3 Triple-layer pipe

The triple-layer pipe structure is produced using the latest co-extrusion technology. Each layer has its own function optimised to reduce sound levels, increase mechanical characteristics and improve the drainage flow.

The grey inner layer improves the drainage flow with a low friction smooth surface that is abrasion resistant and resistant to high temperatures. The middle layer is mineral filled and provides the pipe its excellent air borne noise absorption as well as a high pipe stiffness. The outer layer is impact resistant, has increased UV-resistance and allows installation down to -10°C.

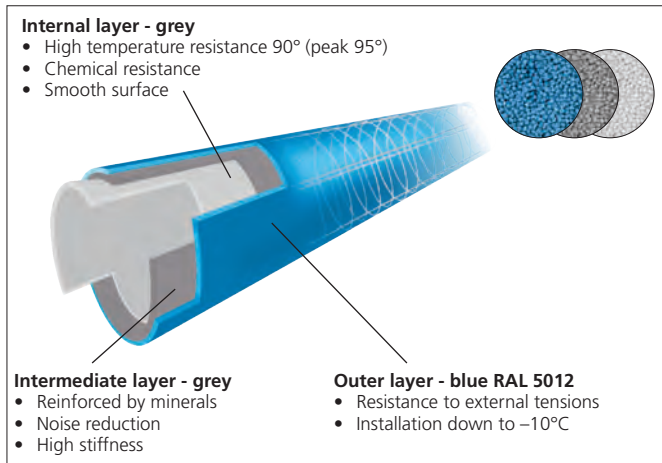

Illustration 1.2

Combined the three layers provide the dBlue system with a pipe suited for a wide range of applications.

One end of each pipe has an integrated socket with rubber ring whilst the other side has a chamfered end which makes the pipe ready to install.

1.4 Uniform fittings

The dBlue fittings have been designed for noise reduction and have many on-site benefits. All fittings are injection moulded (exceptions noted) from PP-MD in a uniform single layer. This provides the fittings with their excellent sound-insulation properties and a constant production quality. The fittings have a mat surface finish and the snap cap rubber ring containment make it a robust fitting.



Illustration 1.3

+ Installation and inspection friendly

The snap cap contains an angle indication for correct positioning. The fitting body has a dedicated area where the installer can mark its position during pre-fabrication. The marking on the fitting is large and highly visible during inspection.

1.5 Acoustic brackets

dBlue metal brackets with rubber lining support the system and contain a rubber lining to dampen the structure borne noise vibrations.

The bracket is a single solution for guide and anchor points in the installation. Use the provided spacers to create a guide bracket in open position. Without spacers the quick close mechanism fully tightens the bracket around the pipe to create a fixed point.

The bracket is installed to the building with a M10 connection nut firmly welded to the bracket.



Illustration 1.4

1.6 Sound insulation

Increased living standards and vertical living have shaped modern installation regulations of drainage systems. In modern urban life noise is around us all the time and this requires proven sound reduction results in each building aspect.

European Directive No.2002/49/EC describes category II as noise measured indoors: 'Building acoustics. Protection of rooms inside buildings against noise. Acceptable indoor sound level values'.

For instance the acceptable noise levels for accommodations in residential buildings, boarding schools, children's homes, care buildings, 4 and more star hotels are 35 dB during daytime and 25 dB at night.

Traditional installation systems don't offer enough acoustic performance and additional insulation is labour intensive.

+ Akatherm dBblue has been independently tested and meets the requirements without additional insulation.

1.7 Packaging, transport and storage

Packaging

Pipes up to 500 mm and fittings are packed in cardboard boxes. Where required, supplementary items in the cardboard boxes will be packed in a plastic bag.

Pipes longer than 500 mm are packed on wooden pallets and fastened with straps.

+ For optimal storage each pallet has additional support spacers (combs) installed to avoid shape deviation of the pipes. Two combs are installed for pipe lengths between 1 and 2 m, and three combs for 3 m long pipes.

The pipes are packed socket end next to spigot end for the proper shape retention.

+ All pallets are wrapped with UV resistant white plastic stretch film, shielding the pipes from UV radiation, dirt, dust and (light) rain.

Local transport

Pipes and fittings still packed in their original packaging (cardboard box or pallet) must be secured against movement and deflection.

Individual lengths of pipe transported loose should be transported 'side by side': socket end next to spigot end for proper shape retention. The pipes must be firmly supported over the entire length and secured from movement and defect.

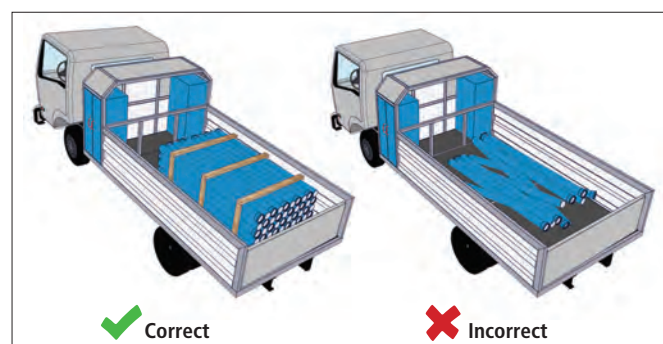

Illustration 1.5

During the transport of pipes and fittings, exposure to rain and snow should be limited.

Storage

Pipes should be stored in their original lengths in stacks on a flat and clean area. Ensure that the wooden frames are aligned squarely when stacking. The first level of the stack should always be laying on the wooden blocks of the pallets.

The maximum safe height of the stack shouldn't exceed 2,5 m.

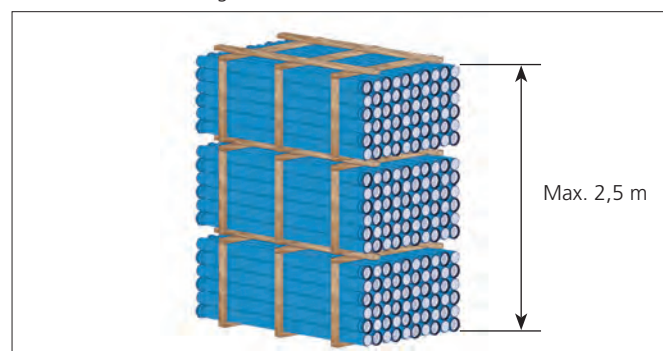

Illustration 1.6

Outside storage of pipe crates is possible when the following guidelines are followed:

- Pipes are protected from direct sunlight (with proper ventilation)
- Storage up to 12 months is possible when the pipes are kept packaged in the original UV resistance stretch foil
- Storage up to 6 months is possible when the pipes are not protected by the original UV resistance stretch film
- Storage temperature should not exceed 60°C

Pipes which have been exposed to UV radiation over a longer period of time can fade in colour. It has no negative effect on the pipe's structure and mechanical resistance.

Store pipes in such a manner that no objects are placed on top of the sockets and spigot ends to ensure that these are not deformed.

Fittings should be kept in their original packaging in a dry covered area and be protected against moisture, dirt, solids and UV radiation.

System information

1.8 Marking

dBlue pipes and fittings are marked with:

- Manufacturer's mark or brand
- Material type
- Nominal diameter
- Area of application
- Conformity of dimensions
- Resistance to low temperatures
- Fire resistance class
- Approvals information
- Information on recycling
- Production year and month

- Production day (pipe only)
- Wall thickness (pipe only)
- Time, shift number and production line number (pipe only)

- EAN barcode (fittings only)
- Angle indication (fittings only)

1.9 Recycling

dBlue pipes and fittings are 100% recyclable.

Left over dBlue materials should be recycled as following:

- | | |
|----------------------|----------------|
| - Remainder pipe | residual waste |
| - Remainder fittings | residual waste |
| - Lubrication | residual waste |
| - Cleaning cloths | residual waste |
| | |
| - Wooden crating | recycled wood |
| - Plastic spacers | residual waste |
| | |
| - Carton boxes | recycled paper |

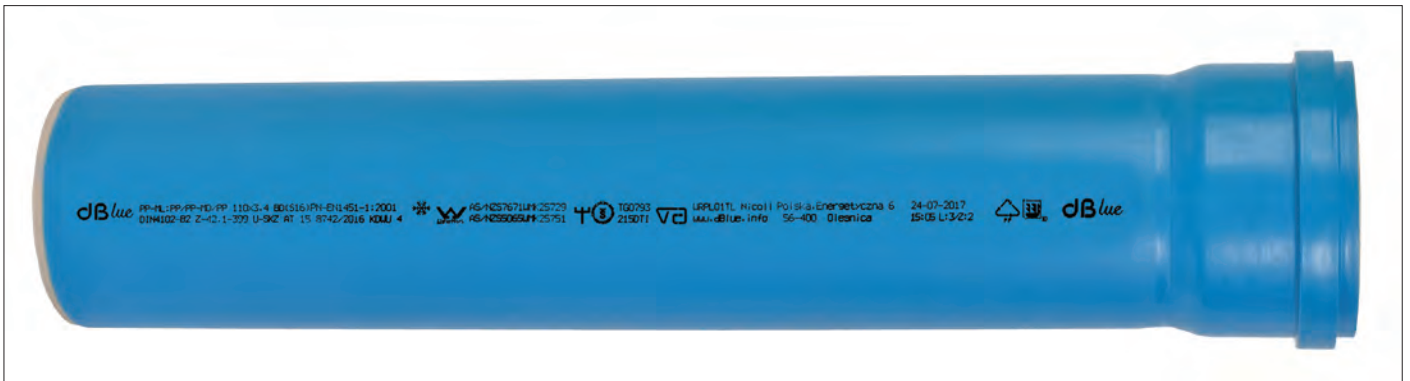

Illustration 1.7

2 Approvals, standards and quality

2.1 Approvals

Akatherm dBlue has been approved the following certification agencies:

Country	Certificate of approval
Australia	
Germany	
Sweden	
Ukraine	
Czech Republic	
Poland	
EN14366 Noise measurement	
EN14366 Noise measurement	

Illustration 2.1

2.2 Standards

Akatherm dBlue is a professional acoustic soil & waste drainage system and meets a number of quality and safety standards.

EN 1451

Plastic piping systems for soil and waste discharge (low and high temperature) within the building structure. Polypropylene (PP). Specifications for pipes, fittings and the system.

EN 1411

Plastic piping and ducting systems. Thermoplastic pipes. Determination of resistance to external blows by the staircase method.

EN 14366

Laboratory measurement of noise from waste water installations.

EN 13501

Fire classification of construction products and building elements.

DIN 4102

Fire behaviour of building materials and building components.

EN 13254

Thermoplastics piping systems for non-pressure applications - Test method for watertightness.

EN 13255

Thermoplastics piping systems for soil and waste discharge inside buildings - Test method for airtightness of joints.

EN 681

Elastomeric seals. Material requirements for pipe joint seals used in water and drainage applications.

Approvals, standards and quality

2.3 Quality management

Akatherm dBlue is developed and manufactured within an ISO 9001 Quality Assurance system. It emphasises on quality care and continuous improvements for customer satisfaction.

Furthermore Akatherm has integrated the ISO 14001 environmental management system to control and improve our overall environmental performance.



Illustration 2.2

2.4 Warranty

Akatherm guarantees the proper functioning of your drainage system by combining training upfront, technical support during construction and (if required) inspection afterwards.

All the Akatherm products have a warranty of 10 years, details are available on request.

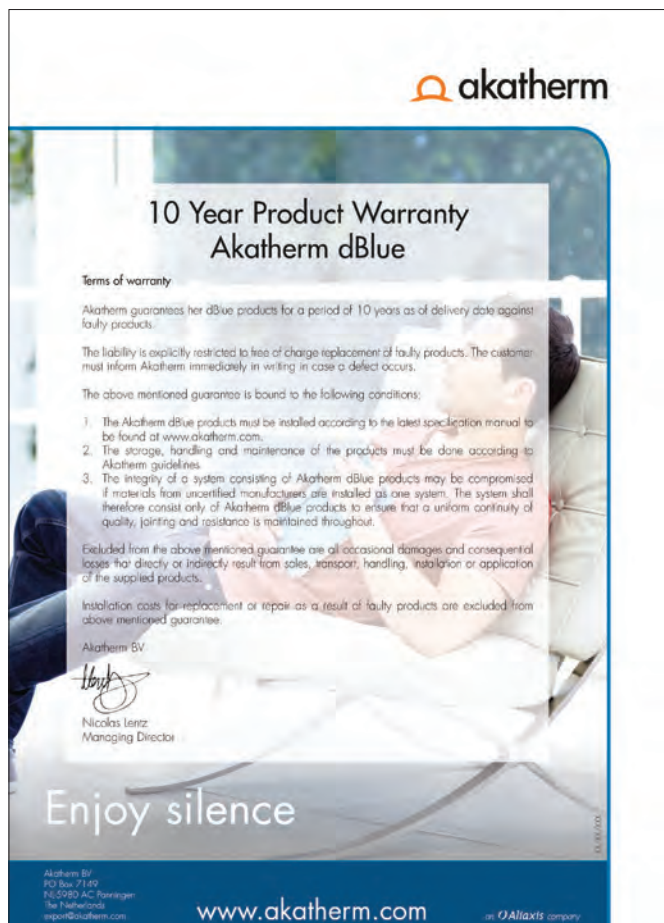

Illustration 2.3

2.5 Akatherm and Aliaxis

Akatherm is a part of Aliaxis, which is the leading producer of plastic pipe systems in the world. The Aliaxis group has over 16.000 employees and comprises of more than 100 companies with subsidiaries in 40 countries. All companies operate under their own brand and are specialized in specific solutions for building, industrial and utility applications.

Akatherm is the brand within Aliaxis focusing on specialist drainage systems in the commercial and industrial building sector. Akatherm has a global network with professional local Aliaxis support offices offering promotional, sales, supply, training and on-site support services.

3 System and material properties

The Akatherm dBlue system is made from a state-of-the-art combination of plastic and sound absorbing mineral filler (PP-MD). The material formula is developed by the Aliaxis R&D laboratory and offers a unique combination of acoustic performance, weight, resistance and mechanical strength. The triple-layer pipe structure is produced using latest co-extrusion technology. Each layer has its own function optimised to reduce sound levels, increase mechanical characteristics and improve the drainage flow.

3.1 Technical specifications

Property	Value
Material	PP-MD mineral-reinforced (pipes and fittings)
Size range	DN40 to DN200
Wall thickness	DN40-50 : 1,8 mm, DN75 : 2,3 mm, DN200 : 6,2 mm DN90 : 2,8 mm, DN110 : 3,4 mm DN125 : 3,9 mm, DN160 : 4,9 mm
Area of application	Drainage pipes in buildings and above ground installation
Chemical resistance	Polypropylene basis No waste water containing benzene Rubber ring made of SBR
Application	Waste water with pH value 2 - 12 Waste water temperature up to 90°C (continuous load) and 95°C for brief periods
Application area (EN1519)	Inside buildings (B) : DN40 to DN50 Inside and under the buildings (BD) : ≥DN 75
Density	Mineral filled layer: 1,4 g/cm ³
Coefficient of thermal expansion	0,10 mm/mK
Coefficient of thermal conductivity	0,25 W/mK
Ring stiffness	> 4 kN/m ²
Colour	Internal layer: light grey (RAL7040) Middle layer: grey External layer: blue (RAL5012)
Structure	Triple-layer pipe Uniform fitting
Connection	Rubber ring joint socket with factory-installed lip sealing ring
Fire behaviour	B2 (normally inflammable) DIN 4102-1 E (normally inflammable) EN 13501-1
Standards and approvals	System tested according to EN1451. Refer to the chapter about approvals, standards and quality.
Sound insulation	0,5 l/s 14 dB 1,0 l/s 16 dB 2,0 l/s 16 dB 4,0 l/s 18 dB All tests were carried out in the accredited Institute for Building Physics Fraunhofer in Germany.
Independent monitoring	Süddeutsches Kunststoffzentrum (SKZ), Germany

Table 3.1

System and material properties

3.2 Properties and benefits

Material advantages



High noise reduction without insulation



Installation possible at temperatures down to -10°C

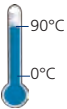

High resistance to waste water temperatures up to 90°C (peak 95°C)



Triple layer pipe is rigid, noise-attenuated with a smooth bore that resists incrustation and blockages

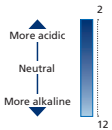

High chemical resistance ranging from pH2 to pH12



Sustainable system
100% recyclable
ISO 14001 certified company

Table 3.2

System advantages



dBblue metal brackets with rubber lining reduce acoustic vibrations to a minimum



Fast installation of rubber ring joints without additional tools



No vent stack required in multi-storey buildings using the dBblue Stack-aerator system



Various solutions available for transition to other materials



Rubber ring joint increases flexibility of the pipe system during ground movement or earthquake



Snap cap technology with tight rubber ring containment and installation angle indication

Table 3.3

4 Sound insulation

4.1 Noise in a soil & waste system

Noise is all around us all the time. In modern urbanised life there are few places left to enjoy the comfort of silence. In many building constructions like multi-storey apartment blocks, hospitals or luxurious spas, the sound of the sanitary and drainage systems have become a significant source of noise. Modern standards require the noise to stay within acceptable limits for everyday use.

Every object in motion makes noise transmitting its vibrations to the surrounding air as pressure waves. There are two types of noise in soil & waste systems:

Airborne noise

This is sound that travels through the air from its source. The source causes the air to vibrate. Airborne noise can pass through structures and is reduced by using absorbent materials.

Structure borne noise

This is sound that first occurs through a solid structure generated from a vibrating source or impact event. The vibrations pass through the structure and reach the human ear as airborne noise at different locations within the building. The building structure acts as an acoustic bridge. Structure borne noise is reduced by using soft material to acoustically uncouple the vibrating source or impact event.

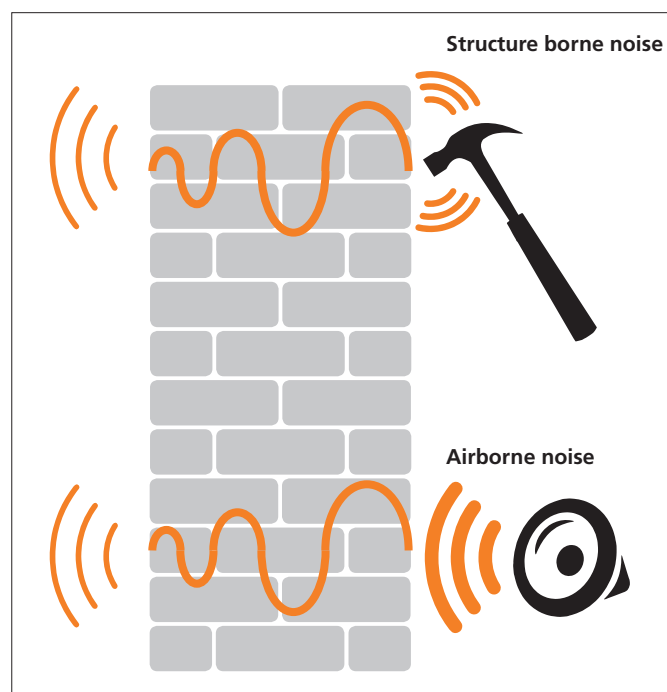

Illustration 4.1

4.2 Sound insulation requirements

The acceptable noise level that a human being can be exposed to while performing everyday activities and relaxing is described as 'the threshold noise level value'. According to the valid regulations, there are two categories of noise tests:

Category I: Noise measured outdoors, for instance a neighbouring area and open spaces. According to European Directive No.2002/49/EC (generally speaking) the acceptable noise in a built-up area during daytime is 60 dB and 50 dB at night (between 10.00 pm and 6.00 am).

Category II: Noise measured indoors. 'Building acoustics. Protection of rooms inside buildings against noise. Acceptable indoor sound level values'.

Table 4.1 presents several examples of the acceptable sound level in rooms designed for everyday stay.

Kind of room	Acceptable average noise level	
	day	night
Rooms designed for mental activities that require intense concentration	30 dB	-
Rooms in 3-star or below 3-star hotels	40 dB	30 dB
Accommodation in residential buildings, boarding schools, children's homes, old people's homes, 4 and more star hotels	35 dB	25 dB
Rooms in intensive medical care units	25 dB	25 dB
Patient's rooms in hospitals and sanatoriums except rooms in intensive care units	30 dB	25 dB
Kitchens and sanitary rooms in residential buildings	40 dB	40 dB

Table 4.1

Sound insulation

4.3 Sound reduction with Akatherm dBlue

Noise in a soil & waste system is caused by waste water flowing inside a drainage pipe system. The waste water is turbulent and causes noise as well as vibrations in the pipe structure.

The vibrations are emitted directly from the pipe surface as airborne noise and as Structure borne noise to the wall through the fixing system. Akatherm dBlue has been designed to reduce both airborne and Structure borne noise.

How Akatherm dBlue reduces airborne noise

Airborne noise is reduced by using absorbent materials. The plastic material PP-MD, used in Akatherm dBlue is made out of a special formula adding sound-dampening mineral fillers with increased weight to maximise the absorbance of airborne sound waves. Triple layer pipe and rubber ring joints further enhance the acoustic performance of the system thus reducing acoustic vibrations.

How Akatherm dBlue reduces Structure borne noise

Structure borne noise is reduced by using soft material to acoustically uncouple the vibrating source or impact event. The dBlue metal brackets with rubber lining have a special rubber lining designed to best uncouple any vibrations from the pipe system.

The combination of all these features is what makes Akatherm dBlue a system that takes reduction of soil & waste noise to the next level.

Non-system specific installation practice will also benefit a lower noise level, like to install the pipe systems to the heaviest wall and to properly insulate a pipe section passing through building slabs and other structural barriers.

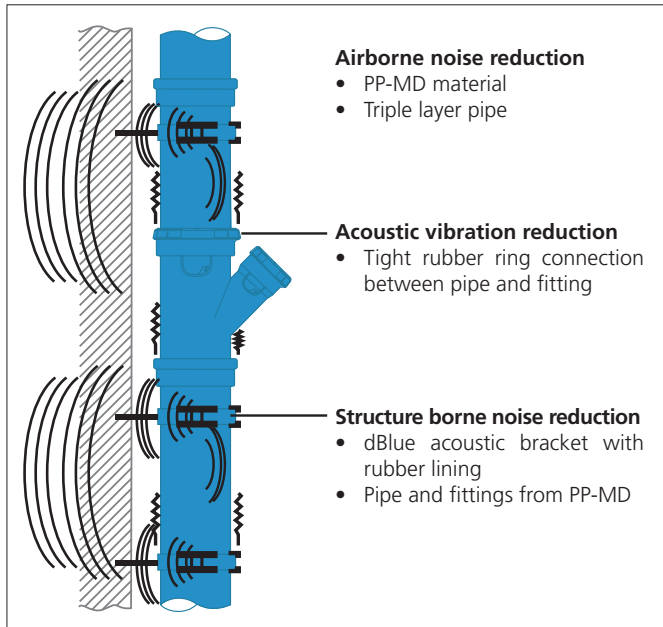

Illustration 4.2

4.4 Acoustic testing

Test and measurements of noise emitted by the Akatherm dBlue system were conducted according to the European standard EN 14366 'Laboratory measurement of noise from waste water installations' and to the requirements set by the Building Code of Australia (BCA).

4.4.1 Testing according to EN 14366

Illustration 4.3 presents noise measurement and its methodology inside the dBlue system. The test stand, diameters and types of components used are described in the standard. Water introduced into the system on the TF(f) floor and received on the C floor was the tested medium. Acoustic tests are conducted in rooms MR(b) and MR(f) and the least favourable boundary conditions are assumed in the comparative analysis with other soil & waste systems or other sources of noise. The boundary conditions are as follows:

- measured flow in the soil and waste system $Q = 0,5/1/2/4$ l/s
- pipe diameter DN = 110 mm (most frequent diameter)
- measurement taken on the lowest floor, in room MR(b) - room marked red in the diagram: safety standards determine and require the lowest noise levels at this point (room neighbouring the soil stack)
- partition wall - weight: 220 kg/m²

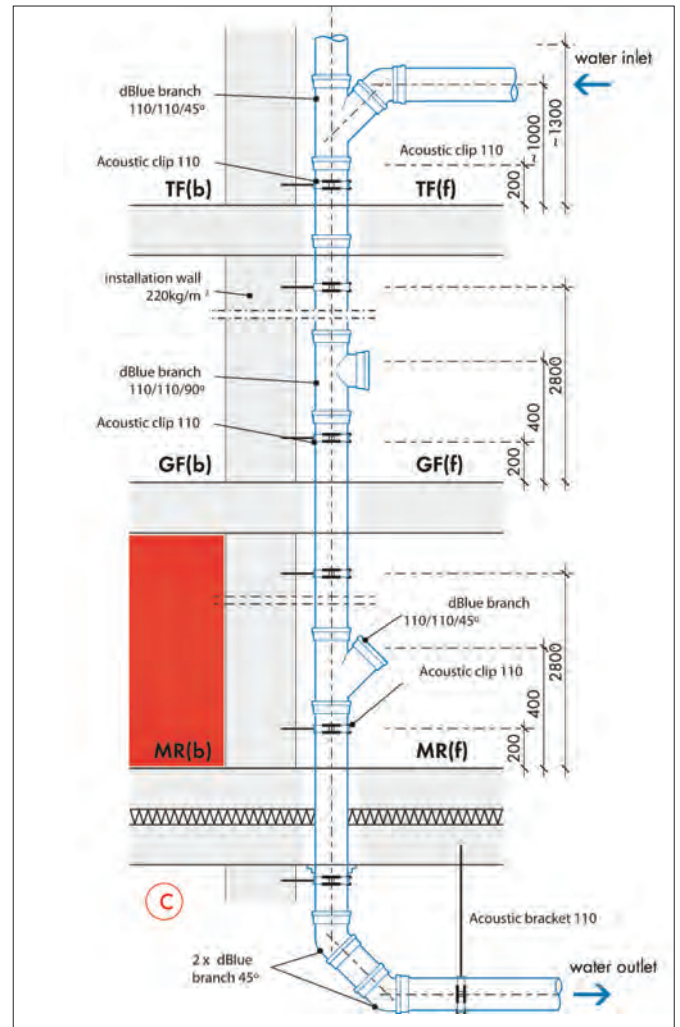

Illustration 4.3

The Akatherm dBlue system is certified at a noise transmission level of 18 dB at a water flow of 4 l/s using dBlue metal brackets with rubber lining. All tests were carried out in the accredited Institute for Building Physics Fraunhofer in Germany. Results are available in test report P-BA 26/2016e.

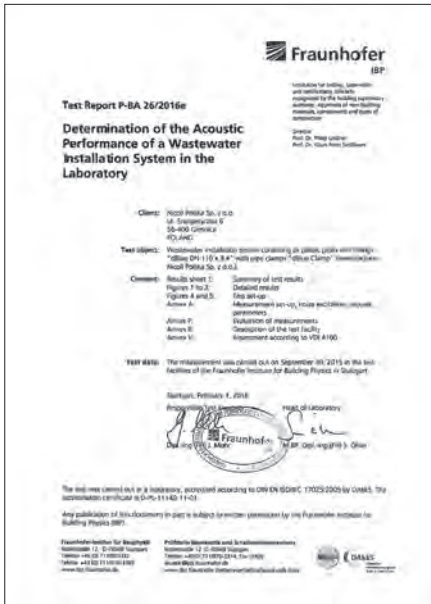

Illustration 4.4

4.4.2 Testing according to Building Code of Australia

The National Construction Code (NCC) Comprises the Building Code of Australia (BCA). BCA Volume One Part F5.6 outlines the requirements for sound insulation.

“If a duct, soil, waste or water supply pipe, including a duct or pipe that is located in a wall or floor cavity, serves or passes through more than one sole-occupancy unit, the duct or pipe must be separated from the rooms of any sole occupancy unit by construction with an R_w+C_{tr} (airborne) not less than:

- I. 40 if the adjacent room is a habitable room (other than a kitchen; or
- II. 25 if the adjacent room is a kitchen or non-habitable room

Akatherm dBlue has been independently tested by the commonwealth Scientific and industrial research organisation (CSIRO) and meets the required R_w+C_{tr} (airborne) benchmarks without the need for lagging.

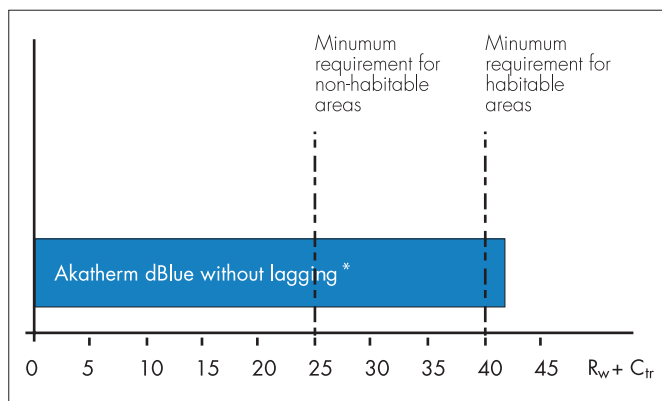

* required R_w+C_{tr} 40 results are extrapolated based on the R_w+C_{tr} 25 results.

Illustration 4.5

+ No acoustic lagging required!
 Akatherm dBlue does not require any additional acoustic lagging, offering many significant advantages:

- No lagging material required
- No lagging installation time
- Less scheduling of companies
- Consistent acoustic results during installation lifetime
- No unverified lagging materials
- Faster and easier inspection
- Faster and easier maintenance

CSIRO is Australia's national science agency, and is one of the largest and most diverse scientific institution in the world with more than 50 sites throughout Australia and overseas. The test results are available in test report MA149/R.

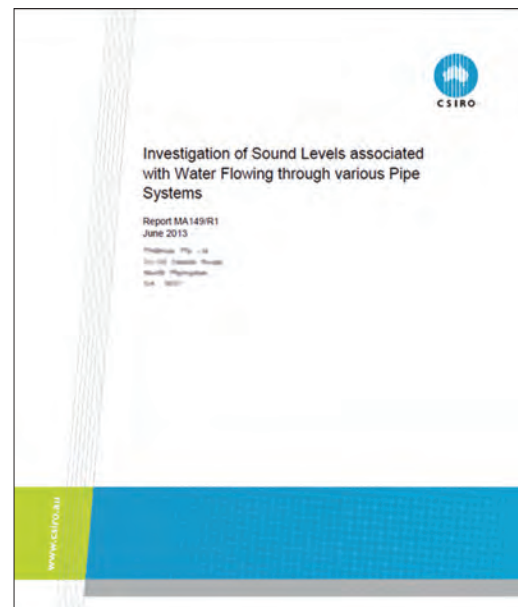

Illustration 4.6

Planning and design

5 Planning and design

5.1 Relevant standards

Akatherm dBlue is designed for drainage systems inside the building. The planning and design shall comply to:

- EN12056 Gravity drainage systems inside buildings
- EN1451 Plastic piping systems for soil & waste discharge (low and high temperature) within the building structure. Polypropylene (PP). Specifications for pipes, fittings and the system.

Additionally planning, design, installation and commissioning shall comply to the guidelines as specified in this manual.

Approvals

Akatherm dBlue is certificated in conformity with EN1451 in many countries like Germany and Sweden.

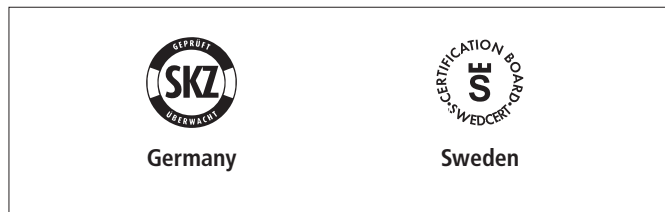

Illustration 5.1

The certifications include all pipe and fittings from size DN40 to DN200.

For a full overview of countries and certifications, please check the chapter about approvals, standards and quality.

Fire behaviour of dBlue

Akatherm dBlue has fire behaviour class B2 (normally inflammable) according to DIN 4102-1 and class E (normally inflammable) according to EN 13501-1.

Standard	Classification
EN 13501-1	Class E
DIN 4102	B2

Table 5.1

European standard EN 13501-1

This standard defines a class system for material behaviour of building products and building constructions. The standard defines a set of phases which contribute to the development and spread of fire and smoke. The phases are described as follows:

- Phase 1: flammability: likelihood of ignition of the material and contribution in the case of a potential flashover.
- Phase 2: Smoke generation: The amount of smoke generated aiding the development and possible spread of the fire.
- Phase 3: flaming drops/parts: Amount of flaming drops/parts generated in the event the construction material has ignited.

Flammability

Class	Fire tests	Flashover	Contribution	Practice
F	Not tested, or does not comply to class E	Not classified	Not determined	Extremely flammable
E	EN-ISO 11925-2 (15 sec-Fs<150 mm-20 sec)	Flashover 100 kW <2 min	Very high contribution	Very flammable
D	EN 13823, Figra <750 W/s EN-ISO 11925-2 (30 sec-Fs<150 mm-60 sec)	Flashover 100 kW >2 min	High contribution	Good flammable
C	EN 13823, Figra <120 W/s + Thr <15 MJ EN-ISO 11925-2 (30 sec-Fs<150 mm-60 sec)	Flashover 100 kW >10 min	Great contribution	Flammable
B	EN 13823, Figra <120 W/s + Thr <7,5 MJ EN-ISO 11925-2 (30 sec-Fs<150 mm-60 sec)	No flashover	Very limited contribution	Very difficult flammable
A2	EN ISO 1182 of EN-ISO 1716 plus EN 13823, Figra <120 W/s + Thr <7,5 MJ	No flashover	Hardly contribution	Practically not flammable
A1	EN ISO 1182 = Not flammable EN-ISO 1716 = Calorific value	No flashover	No contribution	Not flammable

Table 5.2

German Industry standard DIN 4102

According to DIN 4102 materials are tested according to flammability and combustibility. DIN 4102 ratings are specifically divided in degrees of flammability:

Rating	Degree of flammability
A1	100% non-combustible
A2	~98% non-combustible
B1	Difficult to ignite
B2	Normal combustibility
B3	Easily ignited

Table 5.3

Plastics and fire safety

Although most metal pipes are classified as non-combustible, and plastic pipes as combustible, one needs to have a closer look at which drain, waste and vent (DWV) pipe material may be advantageous for life safety in a building fire.

It is important to note that in most fire safety codes, the objectives are not on prevention of fire, but rather on the spread of fire. In other words, construction practices are specified with regard to fire safety that if a fire should break out for some reason, that the building construction practices should be such that this fire is compartmentalized to remain in the compartment of origin, thus allowing sufficient time for fire suppression activities to occur such as fire sprinklers or fire department response.

It is generally conceded that most combustible pipes will be consumed fairly quickly in a fire but does that create a large fire safety risk for the remainder of the building? The answer is no.

The reason it does not is through very effective fire stopping. Fire stopping is the process of applying tested materials and systems to the underside of floors or on both sides of walls whereby the penetration for the pipe will not allow passage of heat or flame to adjacent compartments. It can be argued that fire stopping devices such as collars actually work more effectively with combustible pipe than they would for metal pipe. This is because these devices tend to sever off a combustible pipe very early in a fire as the intumescent material rapidly expands and fills the hole left by the consumed pipe. The end result is a collar fastened to the floor or wall surface that contains a large amount of charred material which is resistant to the passage of flame or significant heat. They are effectively like a lump of coal protecting the hole during the fire and will typically offer sufficient protection.

Fire stopping metal pipe is also somewhat common but works much differently. Since the metal pipe will not be consumed during the fire, the focus of fire stopping is simply to seal off the annular space between the pipe's outside diameter and the hole interior. Mineral wool and firestop caulking can achieve this but there are two concerns with these systems.

One is that the mineral wool plus caulking will not prevent a high level of heat transfer from one compartment to the next through the very conductive metal pipe. Temperature increases on the unexposed side of a pipe penetration can easily exceed 180°C with uninsulated metal pipe. Having this hot stove pipe effect can actually inadvertently ignite combustible materials on the unexposed side of a fire and thus allow continuity of the fire beyond the separation.

5.2 Ceiling penetrations

Each duct in a construction barrier must be constructed with a sleeve made of material that ensures acoustic insulation and prevents against moisture. Proper acoustic insulation will prevent an acoustic bridge through contact noise.

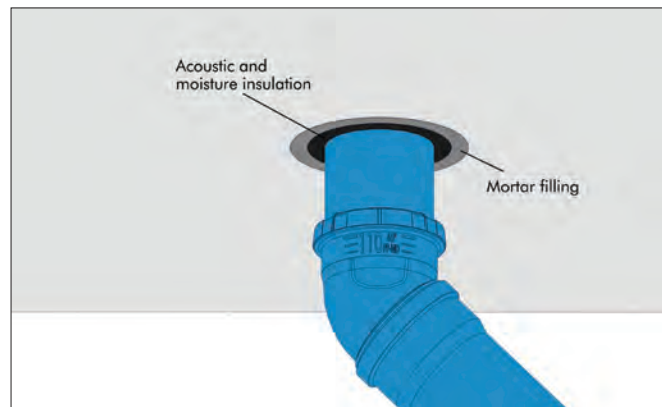

Illustration 5.2

Appropriate protective measures need to be taken when the pipe system can come into contact with hot floor coverings like mastic asphalt.

5.3 Passive fire protection

The fire behaviour of Akatherm dBlue is rated as normally inflammable, class B2 according to DIN 4102. When Akatherm dBlue passes through fire-rated building elements, it is mandatory to install fire protection collars that will not reduce the fire-rating of these building elements and prevent a flashover.



Illustration 5.3

The Akatherm dBlue system can be installed with Promat fire collars as an effective passive fire safety solution.

Certification

Promat fire collars are tested with Akatherm dBlue according to EN1366-3:2009 and hold a fire resistance classification certificate according to EN13501-2:2016.

Measuring passive fire stopping

Passive fire stopping by means of fire collars is measured in terms of integrity and insulation. Stability or structural adequacy is not recorded for service penetrations like pipes, except when those which are required to be load bearing. Integrity failure occurs when cracks, holes or openings occurs through which flames or hot gases can pass.

Insulation failure occurs when the temperature on the unexposed surface of the pipe system exceed a set temperature (~180°C). To prevent failure in interlinked concealed cavities, where pipe systems generally run, it is vital to ensure compartmentation by sealing any and all gaps, including gaps left for structural movement and gaps left due to poor workmanship.

EU standard EN1366-3:2009 is accepted for fire testing in many parts of the world. For specific fire safety testing regulation in conformity with UL, ASTM, BS or AS/NZS please contact your Akatherm sales representative.

Planning and design

5.3.1 Wall penetrations with Akatherm dBlue

Penetrations of fire rated walls require two fire collars on both sides of wall. The origin of the fire is unknown and can come from both sides.

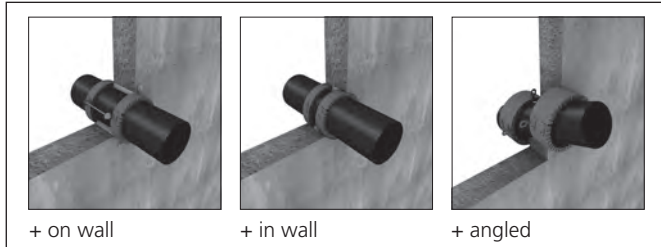

Illustration 5.4

Akatherm dBlue is tested in a variety of wall constructions, please refer to the fire resistance rating chapter.

5.3.2 Ceiling penetrations with Akatherm dBlue

Penetrations of fire rated ceilings require one fire collar installed on the bottom of the ceiling. The heat of the fire and the flashover come only from below.

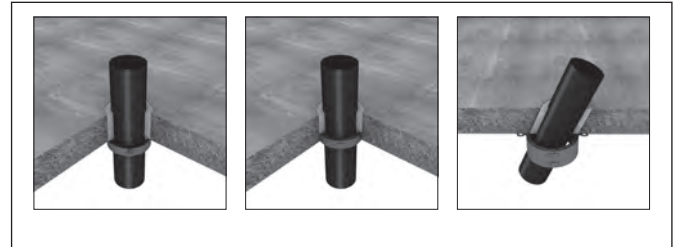

Illustration 5.5

Akatherm dBlue is tested in a variety of ceiling constructions, please refer to the fire resistance rating chapter.

! Applicable national regulations, standards, codes and building practice on fire protection of must be observed.

5.3.3 Promat fire resistance rating for Akatherm dBlue

Promat fire collars are tested with Akatherm dBlue according to EN1366-3:2009 and hold a fire resistance classification certificate according to EN13501-2:2016.

Wall penetrations of Akatherm dBlue pipes

Type	Pipe outer diameter (mm)			Penetration angle	Installation	40	50	75	90	110	125	160	200	
	Thickness	Specification	Promat fire collar			Load bearing / Integrity / Insulation								
Concrete wall	> 100 mm	> 450 kg/m ³	Promastop-FC3	90°	On wall	-/120/120	-/120/120	-/120/120	-/120/120	-/120/120	-/120/120	-	-	
			Promastop-FC6	90°	On wall	-/120/120	-/120/120	-/120/120	-/120/120	-/120/120	-/120/120	-/120/120	-/120/120	-/120/120
			Promastop-FC6	45°	On wall	-	-	-	-	-	-	-	-	-
	> 150 mm	> 450 kg/m ³	Promastop-FC3	90°	In wall	-/120/120	-/120/120	-/120/120	-/120/120	-/120/120	-/120/120	-	-	
			Promastop-FC6	90°	In wall	-/120/120	-/120/120	-/120/120	-/120/120	-/120/120	-/120/120	-/120/120	-/120/120	
Multiboard (wood) wall	> 140 mm		Promastop-FC3	90°	On wall	-/90/90	-/90/90	-/90/90	-/90/90	-/90/90	-/90/90	-	-	
			Promastop-FC6	90°	On wall	-/90/90	-/90/90	-/90/90	-/90/90	-/90/90	-/90/90	-	-	
Sandwich panel wall	> 80 mm		Promastop-FC3	90°	On wall	-/90/90	-/90/90	-/90/90	-/90/90	-/90/90	-/90/90	-	-	
			Promastop-FC6	90°	On wall	-/90/90	-/90/90	-/90/90	-/90/90	-/90/90	-/90/90	-	-	
Light partition wall	> 100 mm		Promastop-FC3	90°	On wall	-/120/120	-/120/120	-/120/120	-/120/120	-/120/120	-/120/120	-	-	
			Promastop-FC6	90°	On wall	-/120/120	-/120/120	-/120/120	-/120/120	-/120/120	-/120/120	-/120/120	-/120/120	
			Promastop-FC6	45°	On wall	-	-	-	-	-	-	-	-	
Shaft wall	> 2 x 15 mm		Promastop-FC6	90°	On wall	-	-	-	-	-	-	-	-	
	> 2 x 20 mm		Promastop-FC3	90°	On wall	-/90/90	-/90/90	-/90/90	-/90/90	-/90/90	-/90/90	-	-	
	> 2 x 25 mm		Promastop-FC6	90°	On wall	-	-	-	-	-	-	-	-	

Table 5.4

Ceiling penetrations of Akatherm dBlue pipes

Type	Pipe outer diameter (mm)			Penetration angle	Installation	40	50	75	90	110	125	160	200	
	Thickness	Specification	Promat fire collar			Load bearing / Integrity / Insulation								
Concrete ceiling	> 150 mm	> 650 kg/m ³	Promastop-FC3	90°	On ceiling	-/120/120	-/120/120	-/120/120	-/120/120	-/120/120	-/120/120	-	-	
			Promastop-FC6	90°	On ceiling	-/120/120	-/120/120	-/120/120	-/120/120	-/120/120	-/120/120	-/120/120	-/120/120	-/120/120
			Promastop-FC6	45°	On ceiling	-	-	-	-	-	-	-	-	-
Suspended ceiling	> 40 mm	2 layers	Promastop-FC3	90°	On ceiling	-/90/90	-/90/90	-/90/90	-/90/90	-/90/90	-/90/90	-	-	
			Promastop-FC6	90°	On ceiling	-/90/90	-/90/90	-/90/90	-/90/90	-/90/90	-/90/90	-/90/90	-	-
Multiboard (wood) wall	> 140 mm		Promastop-FC3	90°	On wall	-/90/90	-/90/90	-/90/90	-/90/90	-/90/90	-/90/90	-	-	
			Promastop-FC6	90°	On wall	-/90/90	-/90/90	-/90/90	-/90/90	-/90/90	-/90/90	-/90/90	-	-

Table 5.5

5.4 Transition from downpipe to collector pipe

At the bottom of the vertical stack the waste water will be at its highest volume and speed. At this point the transition to horizontal must be designed using 2 x 45° fittings with a 250 mm dBlue pipe in between. This will prevent unwanted pressure spikes by allowing air to move freely in the pipe system. Furthermore a gradual transition will decrease the noise level.

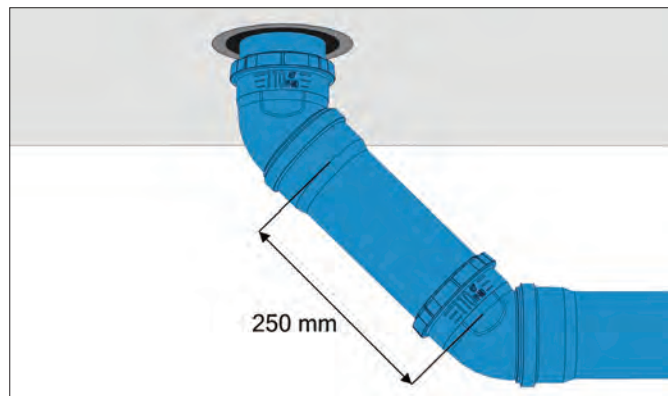

Illustration 5.6

dBlue metal brackets with rubber lining should be installed behind each socket to maximise fixation at the bottom of the stack and absorbing vibrational energy (= noise). To minimise the distance from the collector pipe to the ceiling, the top elbow can be embedded in the ceiling.

5.5 Horizontal change of direction

Ensure gradual horizontal transitions are made using two 45° elbows or swept bend to decrease noise levels compared to the use of a 90° elbow.

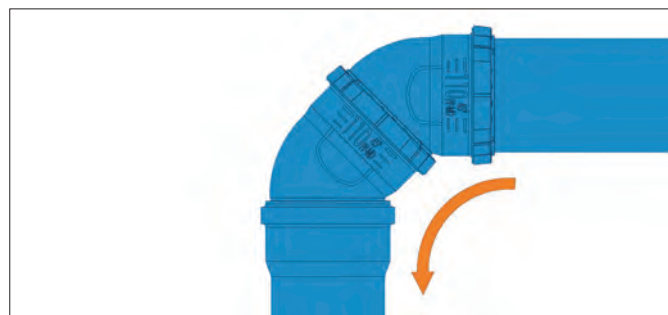

Illustration 5.7

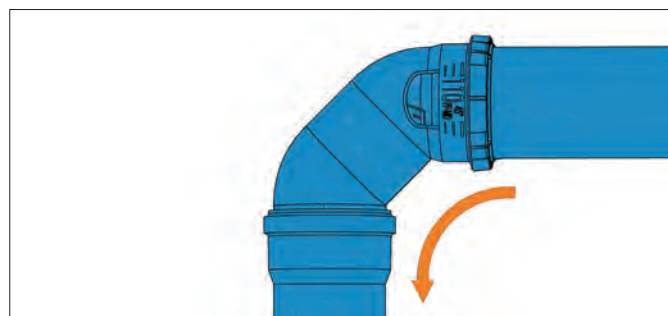

Illustration 5.8

! Do not use more than two fittings to make a horizontal transition.

5.6 Inspection and maintenance

Use the dBlue inspection piece for shaft inspection. Install according to EN12056 specifications.



Illustration 5.9

Place the inspection piece according to the standard joint procedure and tighten the screw cap with rubber seal after installation.

Horizontal pipe inspection

A long horizontal pipe section can be cleaned at the start when the change of direction is installed using a combination of an equal branch, an elbow and an end cap.

Remove the end cap to inspect the horizontal drainage pipe. Clean if required.

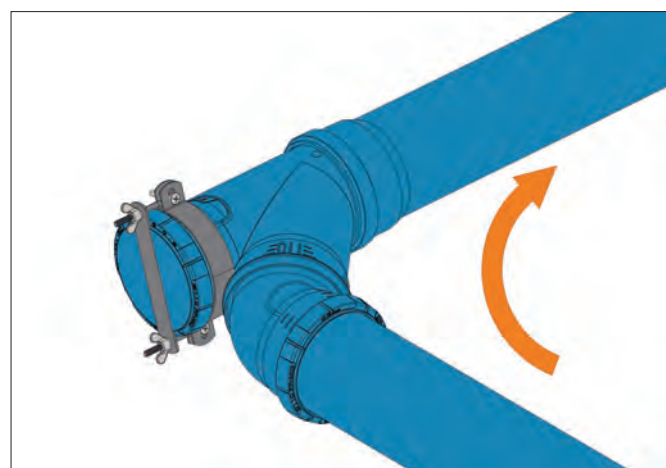

Illustration 5.10

The above illustration shows a 90° bend using a 45° equal branch and 45° degree elbow. Akatherm dBlue has branches and elbows in many angles allowing almost all direction changes.

! The dBlue end cap is pressure tested whilst insterted in fittings and can withstand regular drainage pressure spikes. Additional bracing may be required when (pressure) testing the system.

! Do not use sharp tools for shaft inspection and cleaning.

Planning and design

5.7 Transitions to other materials

5.7.1 PVC system

PVC systems according to BS 4514 have different pipe sizes from Akatherm dBlue below DN110. Refer to the table below for PVC and dBlue pipe sizes.

PVC (BS 4514)		Akatherm dBlue	
DN	OD (mm)	DN	OD (mm)
32	36	40	40
40	43	40	40
50	56	50	50
65	69	75	75
80	82	90	90
100	110	110	110
-	-	125	125
150	160	160	160

Table 5.6

Connection to and from PVC system with non-compatible diameters are possible using adaptor fittings or by using the PVC to dBlue transition.

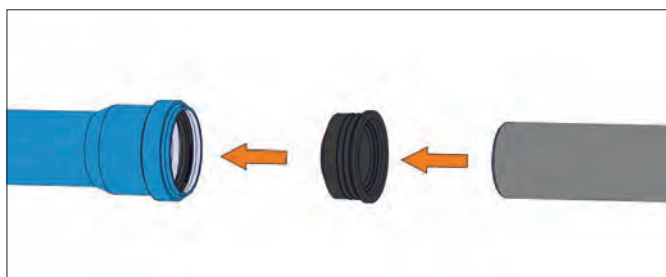

Illustration 5.11

For pipe sizes d110 mm and d160 mm no adaptor fitting is required since both systems have identical outer diameters. The PVC pipe can simply be inserted into the dBlue socket using lubricant.

5.7.2 Cast iron system

Cast iron systems are manufactured with different pipe sizes from Akatherm dBlue. Connections from cast iron systems with non-compatible diameters are possible using cast iron adaptor fittings with rubber ring from the Akatherm dBlue range.

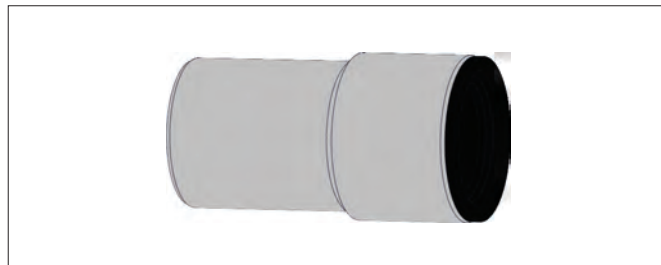

Illustration 5.12

Akatherm dBlue has a straight connection fitting to transition from cast iron to dBlue. Refer to the table below for the possible transitions.

From size	to dBlue	Rubber nipple/spigot
DN	DN	OD (mm)
50	50	58/50
75	75	78/75

Table 5.7

5.7.3 Other materials

For connections from and to other drainage pipe materials it is advised to use flexible rubber sleeve adaptors with stainless steel worm-gear clamps.



Illustration 5.13

The rubber sleeve adaptor should have the same temperature and chemical resistance as the Akatherm dBlue system.

Check the rubber sleeve manufactures guidelines for correct installation and material specifications.

5.8 Bathroom installation

Illustration 5.14 shows an example of a bathroom installation using the Akatherm dBlue system. All direction changes are done using 45° angled fittings to optimise noise reduction. The floor waste gully connects bathroom fixtures like showers, baths and washbasins (all that are not WC) using a single 75 mm trap inside the floor gully.



Cleaning*

The 75 mm trap is removable via the top and is accessed via the grid in the floor above. The floor gully thereby avoids the need for scheduled maintenance via the concealed ceiling like a typical PVC installation.



Illustration 5.14

5.9 Kitchen installation

Illustration 5.15 shows an example of a kitchen installation using the Akatherm dBlue system. All direction changes are done using 45° angled fittings to optimise noise reduction. The floor waste gully connects all kitchen fixtures like dishwashers, washing machines and washing basins using a single 75 mm trap inside the floor gully.



Cleaning*

The 75 mm trap is removable via the top and is accessed via the grid in the floor above. The floor gully thereby avoids the need for scheduled maintenance via the concealed ceiling like a typical PVC installation.

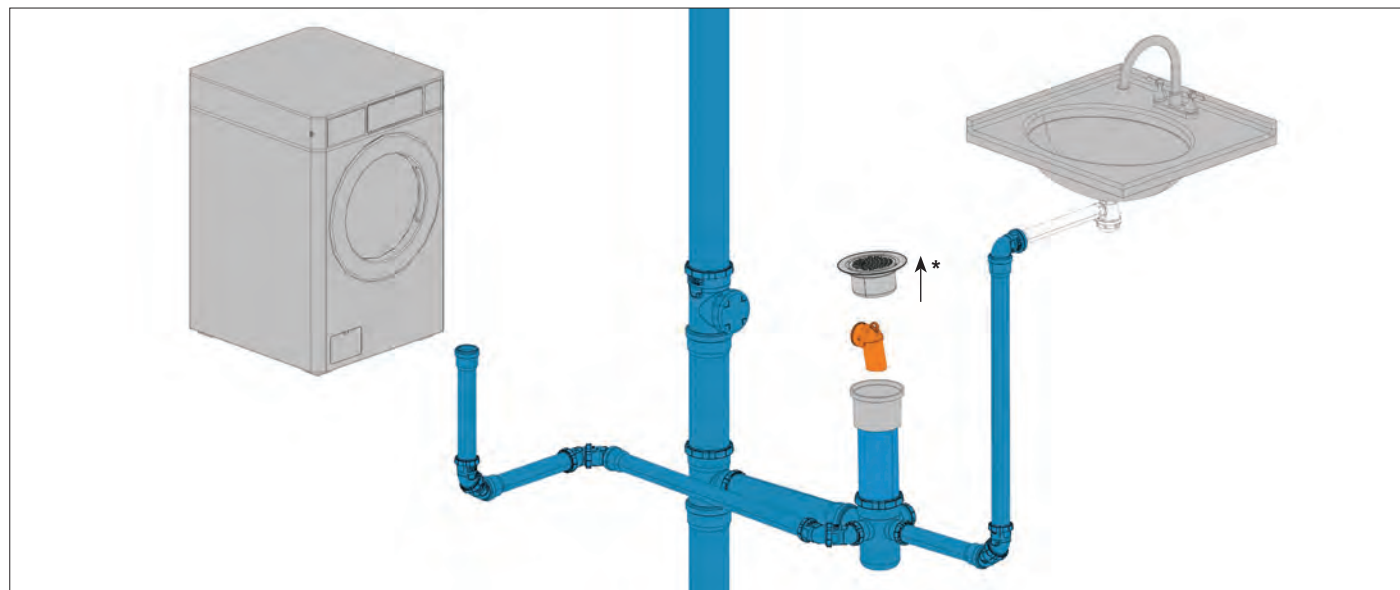

Illustration 5.15

Planning and design

5.10 dBblue high-rise design

5.10.1 Working principle

The dBblue Stack-aerator eliminates the requirement of a vent stack by keeping the air pressure in a single stack system within acceptable limits.

- +** Eliminating the vent stack creates more usable room in the building and extra space for other installations. Furthermore the dBblue Stack-aerator increases the overall flow capacity of the stack, has less installation costs and allows multiple connection per floor.



Illustration 5.16

The air pressure inside a single stack system is kept within acceptable limits by preventing the formation of hydraulic plugs. The fitting prevents hydraulic plugs by breaking the fall on each floor and reducing the speed of the soil & waste flow. Its unique shape smoothly converges the flow of each floor whilst maintaining free movement of air within the downpipe.

The dBblue Stack-aerator is available in DN110 mm and DN160 mm.

5.10.2 Relevant standard

The Stack-aerator system should be designed according to EN12056 and further local regulations.

The Stack-aerator system design information includes (but is not limited to):

- Do not reduce in size
- Maximum 5 x DN100 combined vents
- Use relief lines when offsetting the stack

This manual covers basic design information. Detailed design and calculation information is available in separate documentation.

5.10.3 Stack-aerator system design

System elements

The Stack-aerator system is installed without an additional vent pipe. The system consist of the following elements:

- Stack-aerator on every floor
- Stack-aerator wrapped in sound-insulating material
- Downpipe of dBblue pipe and fittings
- A vent pipe into the atmosphere without reduction in diameter
- A vent pipe at the ground floor transition to the collector pipe

Maximum distance between aerators

The maximum vertical distance between two Stack-aerators is 5 m. Use an additional Stack-aerator if this distance is exceeded.

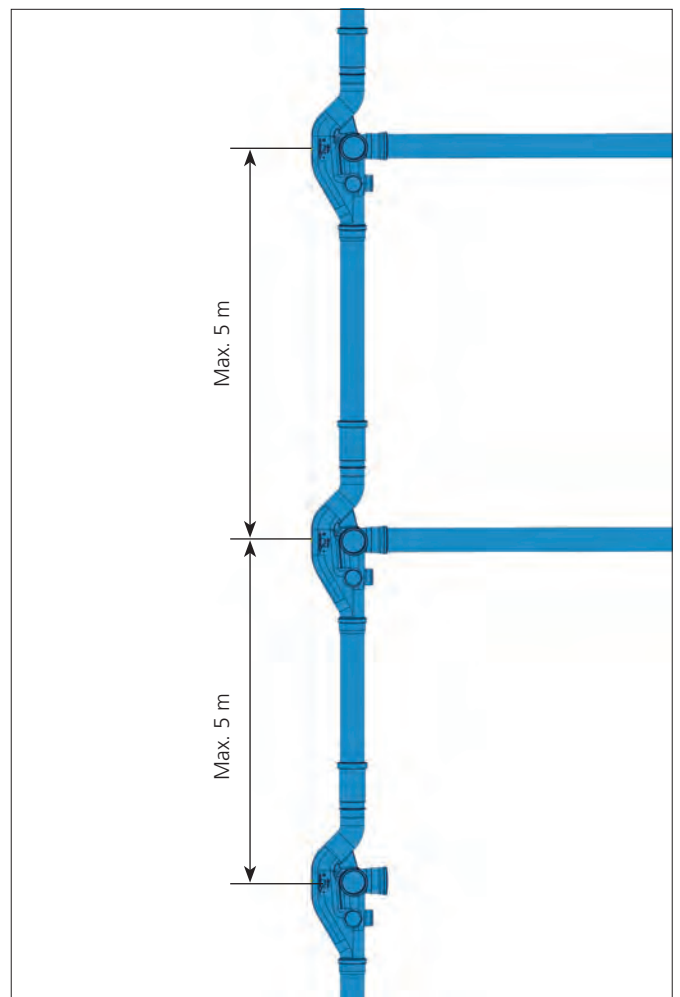

Illustration 5.17

Connecting to the dBlue Stack-aerator

The Stack-aerator will be available on site with all project specific connections pre-installed. Specify configuration when ordering.

The expansion socket at the top is used to insert the pipe coming from the higher floor. The bottom of the Stack-aerator will insert into the socket of the dBlue pipe or fitting continuing down.

Floor connections can be installed into laterally placed push-fit sockets DN110 and DN75. The Stack-aerator has three sockets available per diameter.

! Opposite lateral connections of the same diameter are not permitted.

Further important points of attention during installation can be found in the installation chapter of this manual.

Check the relevant standard for maximum length of floor drainage pipe work allowed to connect before an additional vent solution is required.

Further design instructions are available in separate documentation and include:

- Deflection of the downpipe
- First floor vent design
- Venting the Stack-aerator downpipe into atmosphere
- Zone division of multiple downpipes

5.11 Embedding Akatherm dBlue in concrete

The Akatherm dBlue system is suited to be embedded in concrete. Certain precautions need to be taken during design and installation.

Expansion and contraction compensation

Because Akatherm dBlue and hardened concrete do not adhere, the pipe system embedded in concrete can move freely when expanding under influence of temperature changes. All fittings installed in the pipe system act as an anchor point and are subjected to the expansion force. Make sure to allow for enough expansion joints when designing the pipe system.

Pressure and heat during pouring

When the concrete is poured and is still liquid, the outer pressure can exceed the ring stiffness of the system. Furthermore quick drying concrete will undergo an exothermic reaction (a chemical reaction that is accompanied by the release of heat). The temperatures generated by the exothermic reactions can damage the system materials. Adequate protection must be provided to the Akatherm dBlue system.

To compensate for the outer pressure or the heat, the pipe system can be filled with water and closed making it an incompressible closed system.

Acoustic design

Direct contact between the Akatherm dBlue pipe system and the concrete can cause structural-borne noise. We advise to uncouple the pipe system using a wrapping sleeve made of material that ensures acoustic insulation and prevent against moisture.

! Precisely follow the installation instructions for embedding Akatherm dBlue in concrete.

5.12 Underground installation of dBlue

The Akatherm dBlue system is suitable to be used underground, inside the construction area (within the contours) of a building according to EN 1451.

5.12.1 Surrounding materials

Make sure to allow for enough expansion joints when designing the dBlue pipe system for use underground. When installing, the expansion and shrinkage of surrounding materials should be taken into consideration. All fittings installed in the pipe system act as an anchor point and are subjected to the expansion force.

5.12.2 Load resistance

It is only permitted to use the dBlue system within the contours of the building. Usage outside of this area can be subjected to additional loads (such as traffic loads). The system shall be designed and built in such a way that it can resist the loading that is liable to act on it during its installation and the following building works.

Planning and design

5.13 Stormwater drainage and condensation

When using Akatherm dBlue for stormwater drainage, the relatively cold rainwater can cause dew condensation on the outside pipe surface within the building.

Condensation occurs when the water vapour carried in the air is deposited on a 'colder' surface. Air at a given temperature can contain only a certain amount of water vapour. If the air temperature drops when in contact with the colder pipe system, the excess amount of water vapour will then condense.

The temperature of the air at which air is saturated with water vapour is called the 'dew point'. Condensation occurs when pipework has a temperature under the dew point of the surrounding air. Condensation depends on a number of factors:

- Room temperature
- Relative humidity of the air
- Temperature of the pipe surface

Akatherm dBlue has a relatively good thermal coefficient and no condensation will occur during short periods of rain. To know exactly when and how to insulate, a h-x (Mollier) diagram and a detailed calculation has to be used.

When insulating the pipe system, use diffusion-proof closed cell insulation material. Open cell insulation has to have an impermeable outer layer.

The entire pipe network must be insulated and an insulated pipe system must always be a closed circuit. Always ensure to:

- Close all openings, cuts and transitions with sealing material
- Encasing the bracket fully and seal the transition

In stormwater drainage applications pressure peaks can cause movement in rubber ring connections. To ensure leak tightness of connections incorporate socket retainer clips in the design of the system.



Illustration 5.18

5.14 Professional kitchens

Grease will acculate easier in longer pipe systems wich can lead to serious blockage of the pipe system. Animal and vegetable-based oil and grease discharged by commercial kitchens are separated from the waste water by grease separators. Akatherm dBlue is very well suited to connect the discharge fixtures to the grease separator.

The use of trace heating and additional insulation may be required to reduce heat loss. The trace heating element should not exceed 65°C.

! The performance of the rubber ring seal may be influenced in fat sewage systems in which oil and grease are the main substance. Contact the Akatherm export office before installation.

5.15 Fire protection

Akatherm dBlue has fire behaviour class B2 (normally inflammable) according to DIN 4102-1 and class E (normally inflammable) according to EN 13501-1. When Akatherm dBlue passes through fire-rated building elements it is mandatory to install fire protection collars that will not reduce the fire-rating of these building elements.

We advise to follow the manufacturer's guidelines with respect to design, installation, commissioning and maintenance of the used fire protection collars. Contact the responsible authority for compliance with applicable regulations.

! During design, installation and commissioning of the fire protection collars the applicable on-site, local and national regulations must be observed.

6 Fixing system

Akatherm dBlue is a complete system including dBlue acoustic brackets for optimal sound dampening. The dBlue fixing system includes:

- Bracketing plan in the vertical stack
- Horizontal bracketing plan
- Correct use of guide and anchor point brackets
- Correct tension free installation of each bracket
- Correct installation of each dBlue joint
- Support bracing

Using dBlue acoustic brackets and following the guidelines in this manual will ensure that the Akatherm dBlue soil & waste system will be supported correctly over time and under influence of temperature changes while achieving the desired sound reduction level.

! To achieve the optimal and validated noise reduction levels use only the dBlue acoustic brackets and install them according to this manual.

All dBlue brackets have a M10 nut for connection.

Guide and anchor point bracket

The Akatherm dBlue fixing plan requires the use of guide and anchor point brackets. The dBlue acoustic bracket is designed to function as a guide bracket by using two spacers at the bracket closing point. Without the spacers the bracket fully closes and can be used as an anchor point bracket.

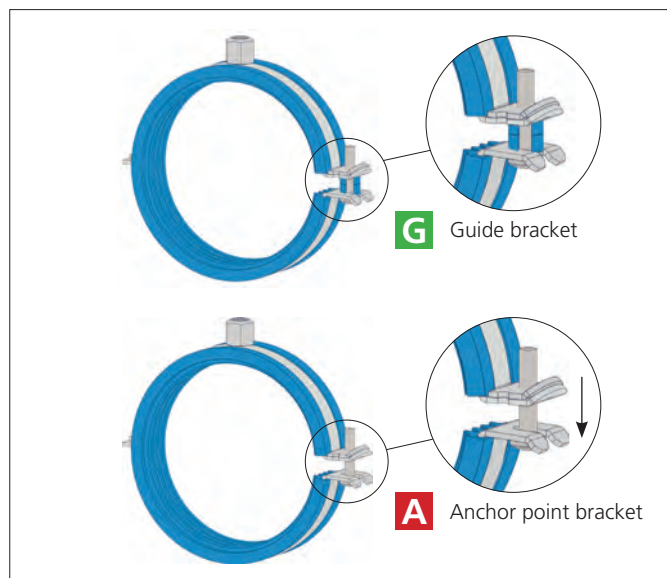

Illustration 6.1

Thermal expansion and contraction

Akatherm dBlue is a rubber ring joint system that takes up thermal expansion and contraction of the pipe system in each joint. This is only possible when following the dBlue joint installation instruction and pulling back the pipe 10 mm after full insertion in the socket. The 10 mm additional room in the joint is sufficient to take up at least 30°C difference between installation and operational temperature.

! Pipes longer than 500 mm have to be pulled back 10 mm after full insertion in the socket to allow thermal expansion of the pipe system.

6.1 Bracketing plan in the vertical stack

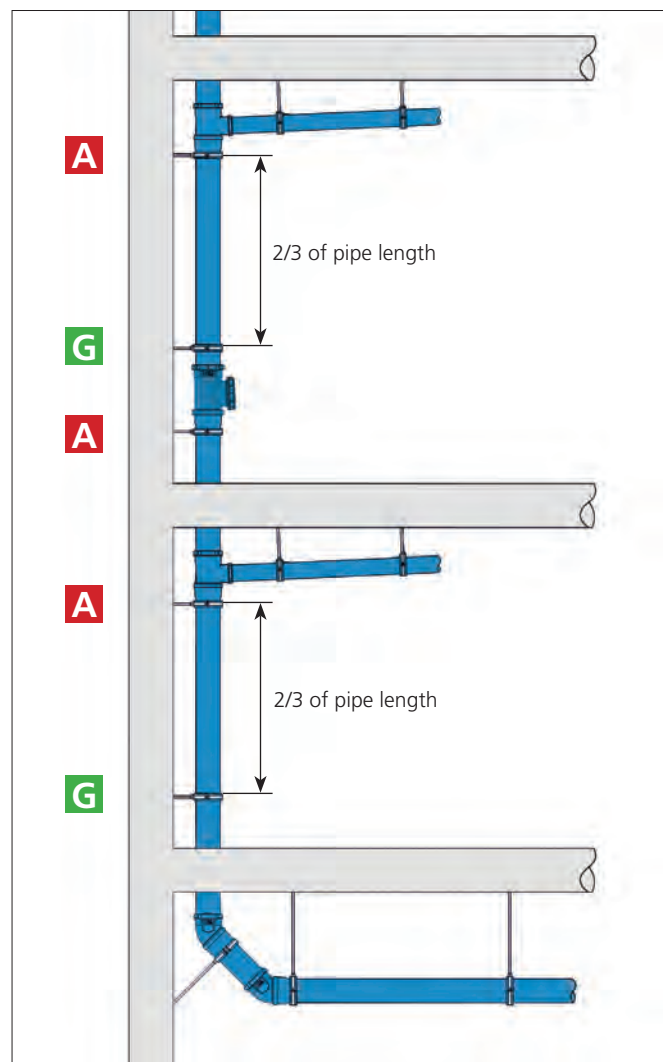

Illustration 6.2

- A** Anchor point bracket (closed without spacers)
- G** Guide bracket closed with 2 spacers

Installation of one fitting per floor level

- Anchor point bracket directly below each socket
- Guide bracket at $\frac{2}{3}$ of the pipe length

Installation of more than one fitting per floor level

- Secure each socket with an anchor point bracket
- Place a guide bracket when the pipe length between the anchor point brackets is more than 20x the pipe diameter

Install an anchor point bracket behind each socket at the bottom of the stack where the downpipe transitions to the collector pipe.

The anchor point bracket fixes the socket in which the thermal expansion can be accommodated. The guide bracket keeps the pipe in a straight line to the next socket.

! Expansion forces will be transmitted to the brackets. Make sure to follow instructions in this manual on support bracing in order to keep all brackets in their original place of installation.

Fixing system

6.2 Bracketing plan in horizontal pipes

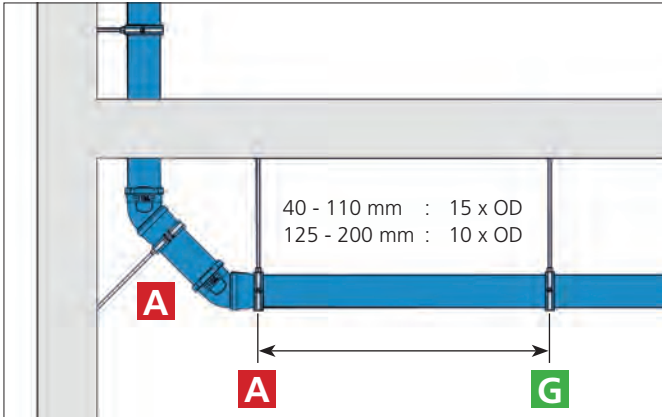

Illustration 6.3

- A** Anchor point bracket (closed without spacers)
- G** Guide bracket closed with 2 spacers

Anchor point brackets

- Always place an anchor point bracket directly behind each socket.

Guide brackets

Horizontal pipe lengths between the anchor points must be supported by guide brackets at regular intervals:

- 40 - 110 mm : 15 x pipe diameter
- 125 - 200 mm : 10 x pipe diameter

When the pipe system layout does not allow specified guide brackets intervals, decrease interval length until possible.

The anchor point bracket fixes the socket in which the thermal expansion can be accommodated. The guide brackets support the pipe to avoid sagging.

- !** Expansion forces will be transmitted to the brackets. Consult the specifications of the pipe rods to determine the maximum allowed length.

6.3 Support bracing

The support bracing used for the dBlue fixing system should be designed to withstand:

- The fully filled weight of the pipe system (W)
- The transmitted expansion forces (E) over the full support length (L)
- The possible forces due to pressure in testing or blockage situations

Pipe system weight

The weight of the pipe system (W) is according to the table below.

Pipe diameter DN	Empty weight (kg/m)	100% filled weight W (kg/m)
40	0,26	1,30
50	0,34	2,03
75	0,65	4,54
90	0,94	6,53
110	1,41	9,94
125	1,82	12,61
160	2,94	20,66
200	4,63	32,27

Table 6.1

Transmitted forces to the bracketing

Several forces will be transmitted to the brackets during testing and use of the system. These can mainly be divided by forces transmitted due to expansion and contraction of the system and forces transmitted to the brackets due to pressures within the system. Whilst Akatherm dBlue is a gravity drainage system in some specific cases (such as testing the system) some pressure may be applied to the system. Proper bracketing will ensure leak free usage of the system.

Transmitted expansion forces

Akatherm dBlue takes up thermal expansion and contraction of the pipe system in each joint. The friction between the rubber ring and the pipe is the resistance force (E) that will be fully transmitted to the threaded rod with length (L). Only this internal resistance is transferred to the pipe when considering expansion forces.

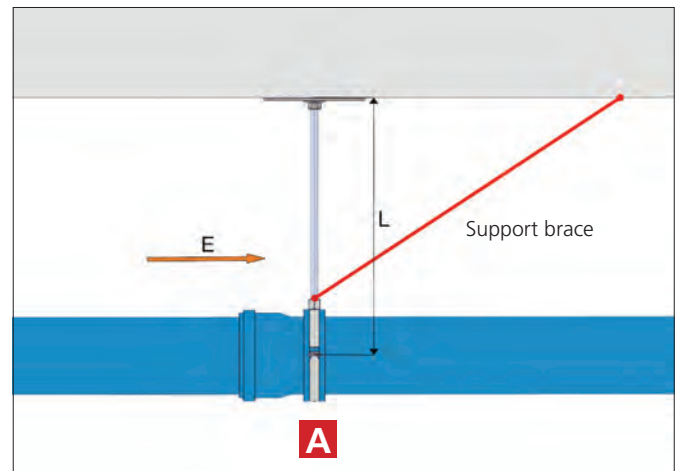

Illustration 6.4

The table below shows the socket resistance force E.

Pipe diameter	Force E	
	DN	(N)
40	200	20
50	200	20
75	250	25
90	300	30
110	400	40
125	600	60
160	800	80
200	1000	100

Table 6.2

Transmitted forces due to pressure

Additional forces may be transmitted to the bracketing system when the system is put under pressure. This can happen in situations where a blockage occurs and in testing situations. Several different scenarios and maximum pressures are described in chapter 7.12 Testing.

The maximum force on the support bracing depends on the maximum pressure within the system and the diameter of the pipe. This can be calculated using the below formula

$$F = (P \cdot \pi \cdot (\varnothing/2)^2) / 10$$

Formula 6.1

- F = Force (N)
- P = Pressure (Bar)
- ∅ = Diameter (mm)

For example, by using the above formula a maximum Force (N) at a pressure of 1 bar with a diameter of 40 can be calculated as 125,7 Newtons.

Calculation of the pressures liable to act on the system during testing and during use and comparing this with the actual force that will be transmitted from pipe to bracing will ensure that the correct rod length is selected.

Consult the pipe rod manufacturers specifications to determine the maximum allowed length. In situations where the actual force exceeds the maximum force allowed bracing may be necessary.

 Akatherm dBlue is designed in accordance with EN1451 in which a maximum testing pressure of 0,5 bar is defined. Pressurisation of the system is not permissible.

Installation

7 Installation

7.1 Shortening and chamfering

dBlue pipes and fittings have factory made sockets and chamfered spigot ends. Pipe is available in several standard pipe lengths. Fittings are not designed to be shortened.

Measure pipe length from end of socket

dBlue pipes are made with sockets that are not part of the true pipe length. Ensure measurements are made from the end of the socket, which will prevent pipes becoming too short.

Cut pipe square

Cut the pipe square using pipe cutters or a fine toothed hand saw for the best results. Fix the pipe before cutting. A mitre box can be used to assist in obtaining a square angle.

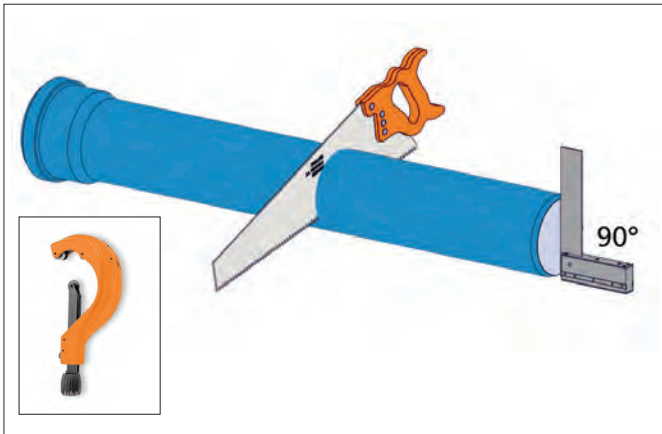

Illustration 7.1

! Do not use high speed electrical cutting tools which will cause heavy burrs and will possibly melt the plastic.

Deburr and chamfer pipe

Proper deburring and chamfering of the pipe is required to allow the pipe to be inserted past the rubber ring in the socket.

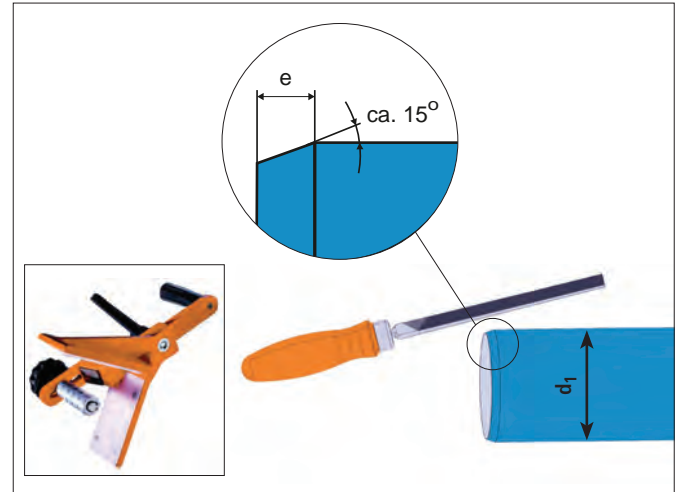

Illustration 7.2

The chamfer angle is always 15°. We recommend the use of a purpose designed chamfering tool for best results. A fine file could also be used but has lesser precision. Remove any leftover burrs using a standard deburring tool.

The chamfer length *e* differs per diameter according the table below. Uncut pipes have chamfer already.

d₁	Chamfer length e (mm)
40	3,0
50	3,5
75	3,5
90	4,5
110	4,5
125	5,0
160	6,0
200	11,0

Table 7.1

Take care when chamfering at low temperatures. Akatherm dBlue is able to be installed at temperatures as low as -10°C without becoming brittle.

! Without deburring and chamfering, the pipe spigot end can damage the rubber ring or even separate it from the socket, both resulting in leakage. Burrs along the edge will prevent lubrication to be distributed uniformly over the pipe.

7.2 Jointing pipes and fittings

When making joints the socket of the pipe or fitting added should be in downstream direction for best flow results.

Clean

Clean the spigot and the socket, including rubber ring, from any dust and dirt.

Lubricate

Always apply plenty of dBlue lubricant at the spigot end and the rubber ring.

! Prevent damage or dirty connections. Do not use scratched pipe ends or fittings. Damaged rubber ring or pipe ends may have a negative impact on the leak tightness of the system.

Insert fully

Each joint must initially be made by fully inserting the spigot end into the entire depth of the socket until it stops (1).

Mark spigot end

Clearly mark the spigot end at the inserted depth with a permanent pencil or pen. Mark the fitting on a clearly visible side. This will allow visual inspection of each joint after installation (2).

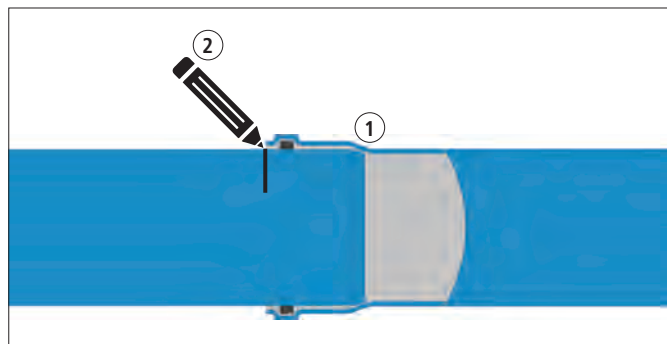

Illustration 7.3

Pull back 10 mm

Pipe that is 500 mm or longer has to be pulled back 10 mm to allow for thermal expansion. Shorter pipes and fittings can remain fully inserted in the socket (3).

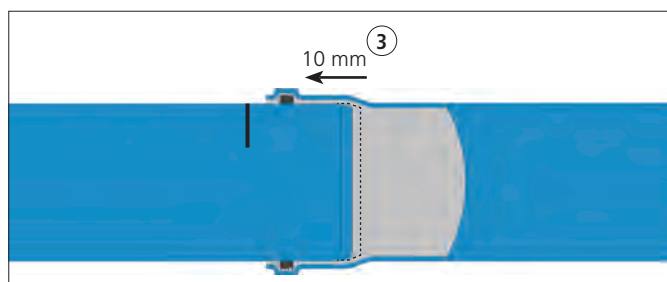

Illustration 7.4

! The dBlue system uses each socket to compensate for thermal expansion of the pipe system under influence of temperature changes.

Pulling back the spigot end 10 mm from the socket creates enough room to allow for 3 m pipe to expand and contract.

7.3 Fixing system

This chapter will describe the correct installation of the the dBlue metal brackets with rubber lining. The Akatherm dBlue bracketing plan requires the use of guide and anchor point brackets.

+ dBlue uses a single bracket type. The bracket is used as a guide bracket when installed with the supplied spacers and as an anchor point bracket without spacers.

Guide bracket installation

The the dBlue metal brackets with rubber lining is designed to function as guide bracket in open position by using two spacers at the bracket closing point.

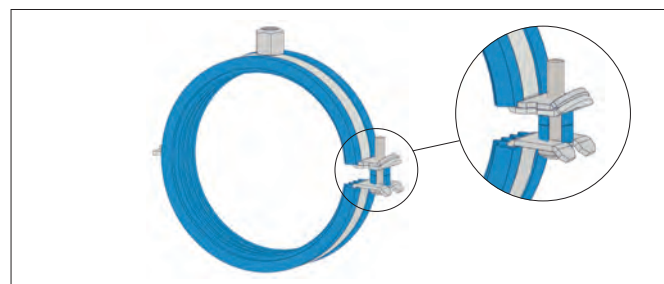

Illustration 7.5

The spacers are not pre-installed and should be placed around the screw between the bracket 'ears'. With the spacers installed the bracket can be closed without creating an anchor point.

Anchor point bracket installation

the dBlue metal brackets with rubber lining is designed to function as an anchor point bracket when in fully closed position (without spacers).

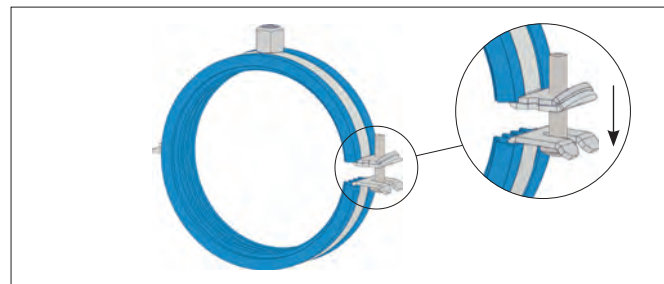

Illustration 7.6

Bracket connection to the wall and ceiling

All dBlue brackets have a M10 nut for further connection to the wall and ceiling. The suspension should be level and tension free.

Akatherm dBlue is a complete system including the dBlue metal brackets with rubber lining for optimal sound dampening. The Akatherm dBlue fixing system includes:

- Bracketing plan in the vertical stack
- Horizontal bracketing plan
- Correct use of guide and anchor point brackets
- Correct tension free installation of each bracket
- Correct installation of each dBlue joint
- Support bracing

! Follow the design guidelines for the vertical and horizontal bracketing plan, support bracing and correct installation of each dBlue joint as described elsewhere in this manual.

Installation

7.4 Transitions to other materials

7.4.1 PVC system

PVC systems have different pipe sizes from Akatherm dBlue below DN110. Connections from PVC systems with non-compatible diameters is possible using PVC to dBlue transitions.

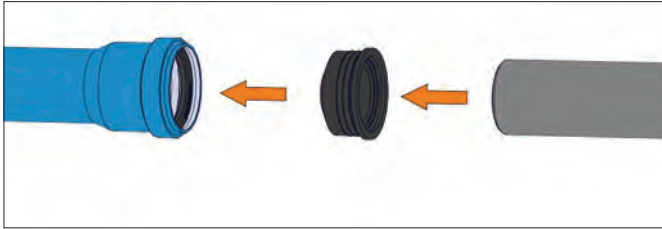

Illustration 7.7

Install the PVC to dBlue transitions according to the following instructions:

Clean

Clean the PVC to dBlue transition, the PVC pipe and the rubber ring inside of the dBlue socket from any dust or dirt.

Connect dBlue socket first

Insert the PVC to dBlue transition inside the dBlue socket. Apply lubricant to the inside of the transition.

Connect PVC Side

Apply lubricant to the spigot of the pipe and insert into the PVC to dBlue transition. Ensure that the pipe is fully inserted all the way to ensure uninterrupted flow.

! The transition adaptor needs to be pushed in firmly all the way to ensure uninterrupted flow.

For pipe sizes DN110 and DN160 no adaptor fitting is required since both systems have identical outer diameters. Refer to the table below for possible transition using the PVC to dBlue transition. Transitions outside of the possible range for the PVC to dBlue transition can be made with the transition for other materials to dBlue.

From PVC (BS 4514)	to dBlue DN	PVC to dBlue transition
36	40	TRA-PVC-036-040
53	50	TRA-PVC-043-050
56	75	TRA-PVC-056-075

Table 7.2

Other materials to dblue

For connections from other drainage pipe materials we advise the use of flexible rubber sleeve adaptors with stainless steel worm-gear clamps.



Illustration 7.8

Rubber sleeve adaptors compatible with the dBlue system are available in the product range and cover a wide variety of different pipe sizes.

Min OD (mm)	Max OD (mm)	Other materials to dBlue transition
42	50	TRA-050-050-000
75	90	TRA-090-090-000
105	120	TRA-110-110-000

Table 7.3

7.4.2 Cast iron system

Cast iron systems are manufactured with different pipe sizes from Akatherm dBlue. Connections from cast iron systems with non-compatible diameters are possible using cast iron adaptor fittings from the Akatherm dBlue range.

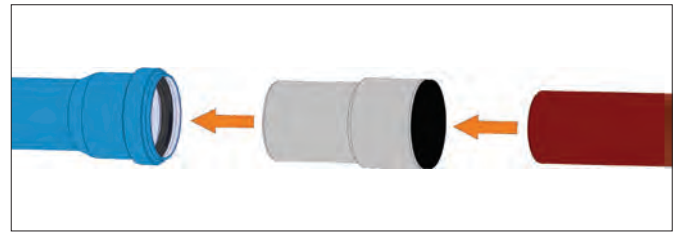

Illustration 7.9

Install the cast iron adaptor fittings according to following instructions:

Clean and deburr

Clean the cast iron adaptor, the cast iron spigot socket as well as the rubber ring inside of the dBlue socket from any dust and dirt. Ensure the cast iron spigot is free from burrs.

Connect cast iron

Apply lubricant to the inside of the rubber nipple and outside of the cast pipe. Fully insert the drainage pipe until it stops. Connect the dBlue spigot side as a regular dBlue fitting.

! The transition adaptor needs to be pushed in firmly all the way to ensure uninterrupted flow. When adjusting the inserted pipe ensure the rubber nipple stays fully inserted into the socket. Use lubricant to allow good pipe movement.

Refer to the table below for the possible transitions.

From cast iron DN	to dBlue DN	Cast iron adaptor OD (mm)
50	50	58/50
75	75	78/75

Table 7.4

7.5 dBlue Stack-aerator

The Stack-aerator will be delivered with an expansion socket welded to the top and the required 110 mm and 75 mm plug-in sockets for lateral floor connections. Install the Stack-aerator according to the following steps:

Clean and chamfer

Clean all rubber ring sockets from dust and dirt. Chamfer and deburr the bottom spigot end according to instructions of dBlue pipes.

Install Stack-aerator in the downpipe

The expansion socket at the top of the Stack-aerator has a factory made anchor point construction where a dBlue acoustic anchor point bracket can be placed.

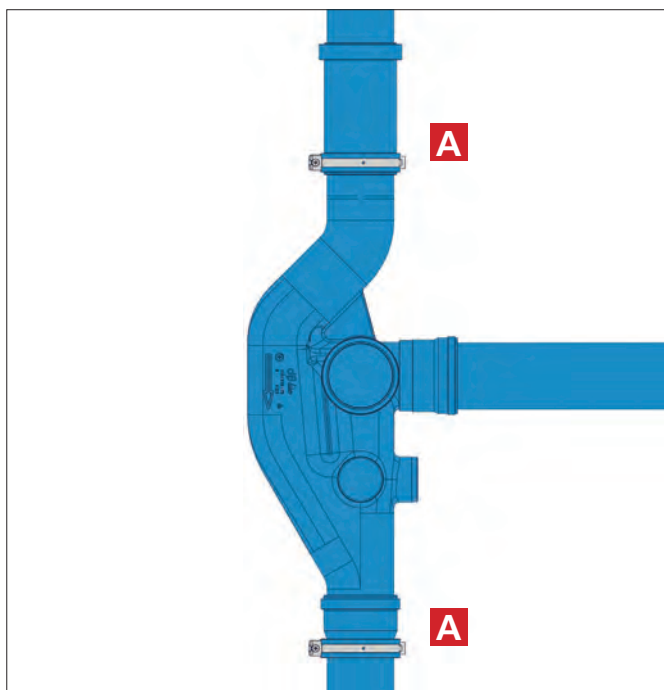

Illustration 7.10

The pipe socket at the bottom of the Stack-aerator must also contain an anchor point bracket as per the vertical bracketing plan.

Install lateral floor connections

Connect the floor connections to the Stack-aerator according to standard instructions. Place anchor point and guide brackets on the horizontal pipe system according to the horizontal bracketing plan.

Optionally insulate the Stack-aerator

The Stack-aerator is bracketed with dBlue acoustic brackets which dampen Structure borne noise. When airborne noise is critical at the position of the Stack-aerator, fully wrap the Stack-aerator in sound insulation material.

7.6 Floor waste gully

The dBlue floor waste gully is equipped with:

- 3x closed 50 mm socketed side inlets
- 1x open 110 mm socketed top inlet
- 1x open 75 mm socketed side outlet
- Trap with 75 mm water height

! The snap caps and rubber rings of the 50 mm side inlets must be installed after drilling open the required inlets.

Install the floor gully according to the following steps:

Open the required inlets

Drill a hole through the gully body for the required inlets using a 45 mm hole saw. Temporarily remove the trap from the floor gully preventing damage.



Illustration 7.11

Insert rubber seals and install snap caps

Insert the rubber seals and install the snap caps to the 50 mm inlets. Any 50 mm inlet that has not been utilized can have their seal and cap installed for potential future use. Re-insert the trap.

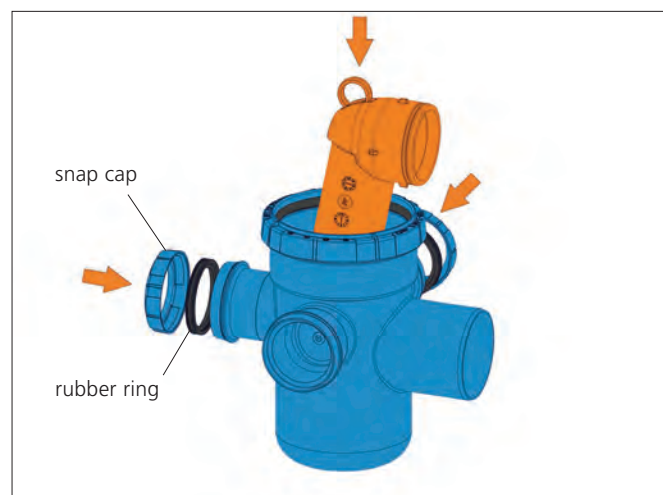

Illustration 7.12

Installation

Place floor waste gully beneath slab

Insert the top inlet over the 110 mm pipe coming through the slab penetration.

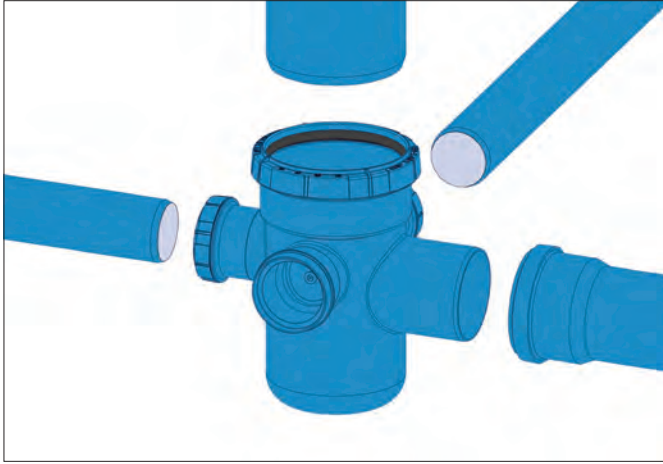

Illustration 7.13

Fixate the floor gully to the slab

Secure the floor gully to the ceiling using anchor point brackets on the 75 mm outlet and opposite 50 mm inlet.

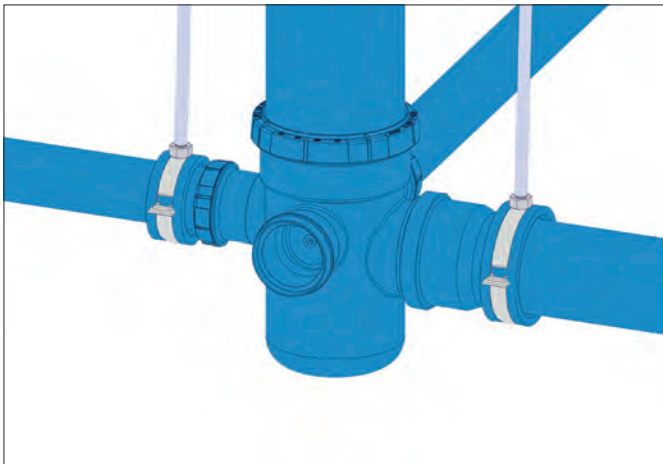

Illustration 7.14

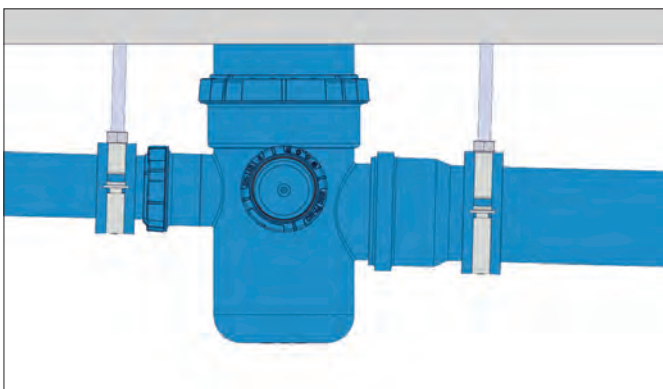

Illustration 7.15

7.7 Disconnecter trap and 4-way riser

The 4-way riser and disconnecter trap combine into a flexible fitting with multiple side connections and a 110 mm connection and trap. The dBlue 4-way riser is equipped with:

- 4x closed 50 mm socket side inlets
- 1x open 110 mm socket top inlet
- 1x open 110 mm spigot bottom end

! The snap caps and rubber rings of the 50 mm side inlets must be installed after drilling the required inlets.

Install the 4-way riser and disconnecter trap according to the following steps:

Open the required inlets

Drill a hole through the gully body for the required inlets using a 45 mm hole saw.

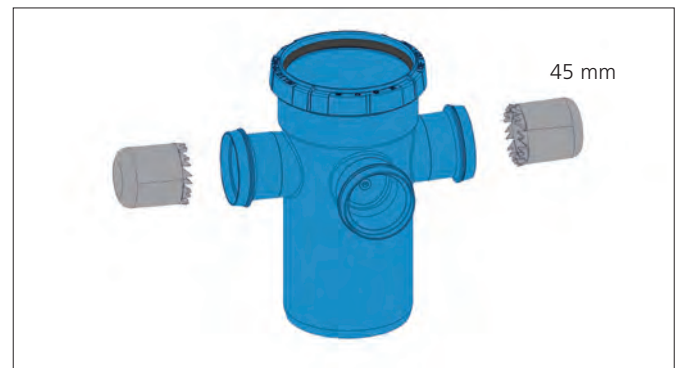

Illustration 7.16

Insert rubber seals and install snap caps

Insert the rubber seals and install the snap caps to the 50 mm inlets. Any 50 mm inlet that has not been utilized can have their seal and cap installed for potential future use.

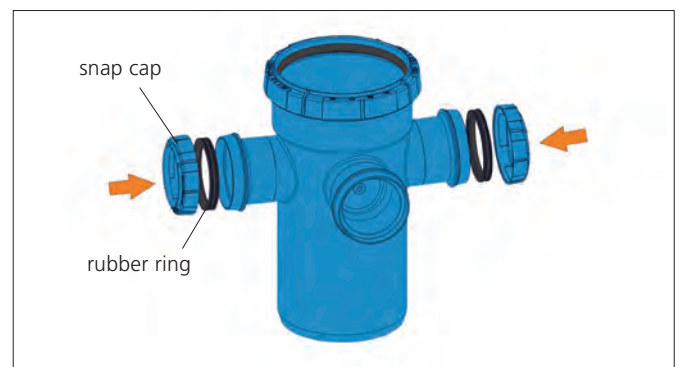

Illustration 7.17

Place 4-way riser and disconnecter trap beneath slab

Insert the top inlet over the 110 mm pipe coming through the slab penetration.



Illustration 7.18

Fixate the disconnecter trap to the slab

Secure the disconnecter trap to the slab using an anchor point bracket.

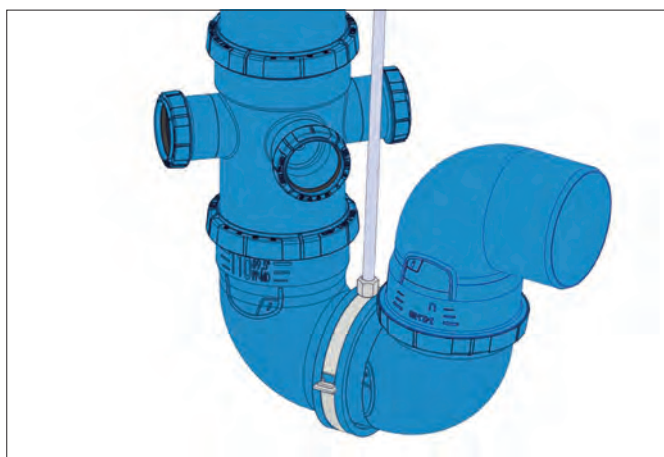

Illustration 7.19

Install side inlets and discharge pipe

Continue installation with the 50 mm side inlets. Place a 87,5° elbow to continue with the discharge pipe system.

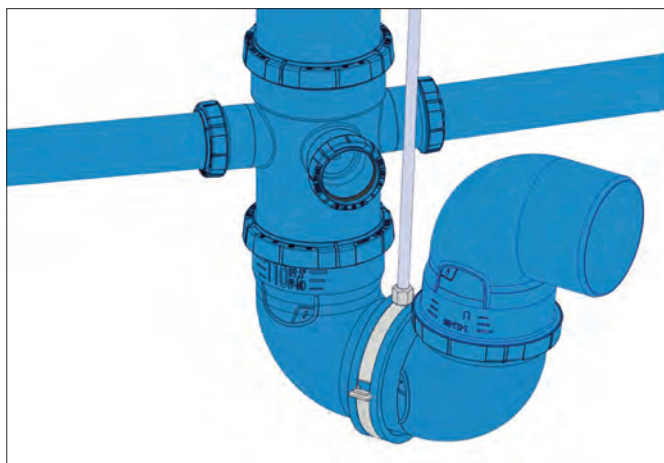

Illustration 7.20

7.8 Embedding Akatherm dBlue in concrete

The Akatherm dBlue system is suited to be embedded in concrete. However certain precautions need to be taken during design and installation.

Follow the instructions in the planning and design chapter on:

- Expansion and contraction compensation
- Pressure and heat during pouring
- Acoustic design

When installing Akatherm dBlue in concrete always:

- Seal each joint with a wrapping sleeve before pouring, this will prevent concrete from entering
- Close open pipe sections before pouring
- Secure the pipe system against movement
- Avoid walking on the pipe system
- Avoid placing weight and steel reinforcements directly on pipe system

! Use extra care when installing dBlue in concrete because it is difficult to reach after installation.

7.9 Fire protection

Akatherm dBlue has fire behaviour class B2 (normally inflammable) according to DIN 4102-1 and class E (normally inflammable) according to EN 13501-1. When dBlue passes through fire-rated building elements, it is mandatory to install fire protection collars that will not reduce the fire-rating of these building elements. In case double sockets are used on a vertical pipe take care to prevent sliding of the system.

! Fire collars can be installed casted within the concrete slab or retro-fitted after the slab and pipe are installed.

Fire collars must be installed around the pipe only, not around the socket.

We advise to follow the manufacturer's guidelines with respect to design, installation, commissioning and maintenance of the used fire protection collars. Contact the responsible authority for compliance with applicable regulations.

! During design, installation and commissioning of the fire protection collars the applicable on-site, local and national regulations must be observed.

Installation

7.10 Using pipe remainders without a socket

Pipe without socket can be used in combination with a double socket. Make sure to follow the deburr, chamfer and joint procedure.

Install an anchor point bracket in the middle of each double socket, which will ensure no movement of the fitting.

Allow for sufficient expansion room.

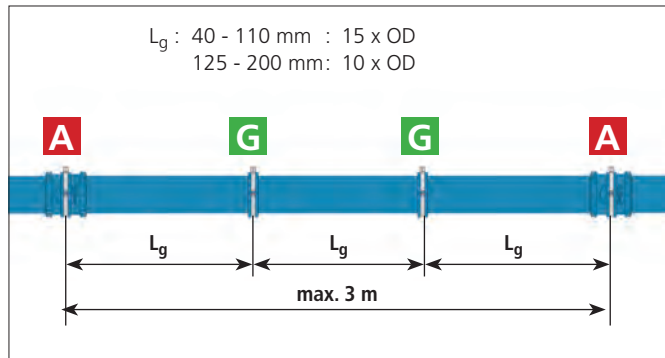

Illustration 7.21

7.11 Additions to an existing system

Modifications and additions to existing systems is possible using sleeve couplers. The sleeve coupler has no centre stop and slides over a pipe completely. Install an additional fitting according to the following steps:

Remove pipe section

Cut out a sufficiently long section of pipe from the pipeline so the additional fitting has room to be inserted. Length of section to cut out according to illustration 7.22 dimension L_t :

$$L_t = \text{fitting length} + 2 \times \text{pipe outer diameter}$$

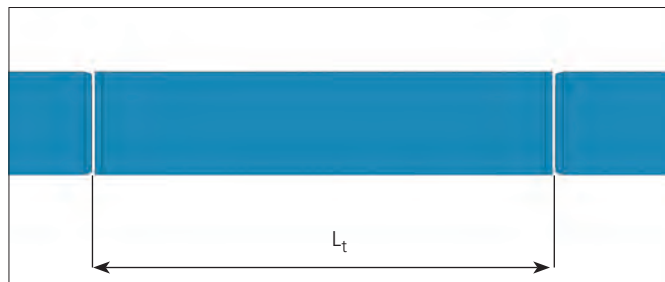

Illustration 7.22

Chamfer and deburr pipe ends

Chamfer and deburr the two pipe ends in the existing pipe system.

Install fitting

Assemble the fitting at the required position using lubricant.

Shorten pipe exactly to size

Measure the remaining gap between fitting and pipe according to dimension L_c in illustration 7.23. Cut the pipe to the required length, chamfer and deburr both ends.

Mount sleeve couplers

Slide one sleeve coupler completely over the cut out pipe section and one sleeve coupler completely over the remaining pipe end using plenty of lubricant.

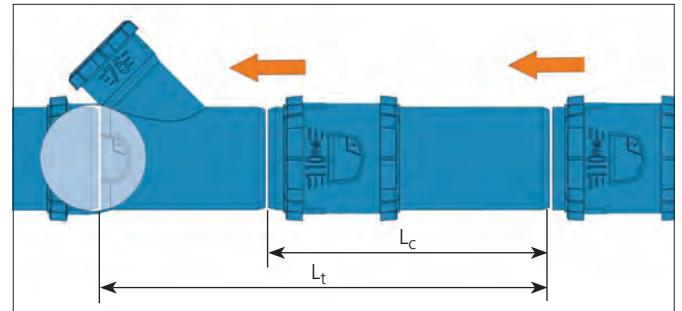

Illustration 7.23

Complete installation

Insert the pipe section and slide the sleeve couplers into their correct place, halfway over both pipes.

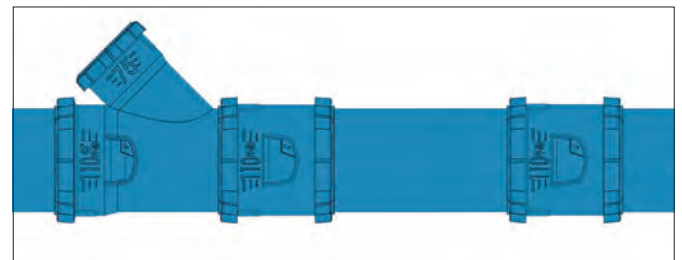

Illustration 7.24

Use plenty dBlue lubricant so the sleeve couplers slide properly.

7.12 Testing

Testing of rubber ring joint gravity drainage systems is important to assess the correct installation and following use of the drainage system. The testing is regulated via the EN12056-5: Gravity drainage systems inside building - Part 5: "Installation and testing, instructions for operation, maintenance and use".

There is no need for a water test to be applied for the whole plumbing system at once. The maximum pressures during such test would far exceed the maximum pressures during a blockage of the system. The part of a drainage system which is principally at highest risk, is that situated below the level of the lowest sanitary appliance. Before testing these parts will have to be identified.

The dBblue gravity drainage system is to be tested using the methodology described in this chapter.

! Where there are water restrictions or the network provider has a water management strategy, hydrostatic testing may not be permitted, in which case an air or vacuum seal test must be conducted. Testing using smoke systems is not recommended.

! During design of the system inspection openings should be added to allow for inspection, maintenance and testing.

7.12.1 Identify maximum pressure values

Various blockage scenarios can be identified to find the maximum pressure values relevant for specific situations. Important is to recognize that the maximum water height is limited by the lowest sanitary appliance as this will be an exit point of the pipe system. Situations can be grouped in the following categories depending on the severity of the blockage:

- Single appliance
- Multiple appliances
- In the stack

Single appliance

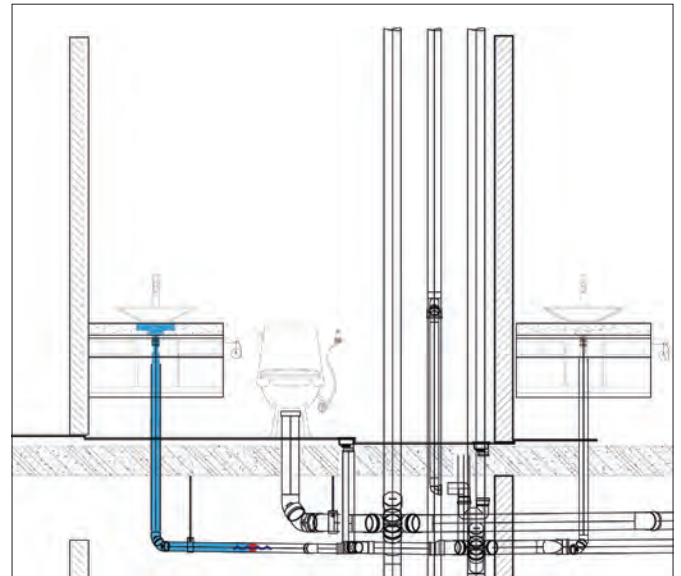

Illustration 7.25

A blockage directly between a sanitary appliance and the stack. No other sanitary appliance is blocked. The maximum amount of pressure in the system is directly related to the point of the blockage and the total height of the sanitary appliance.

Multiple appliances

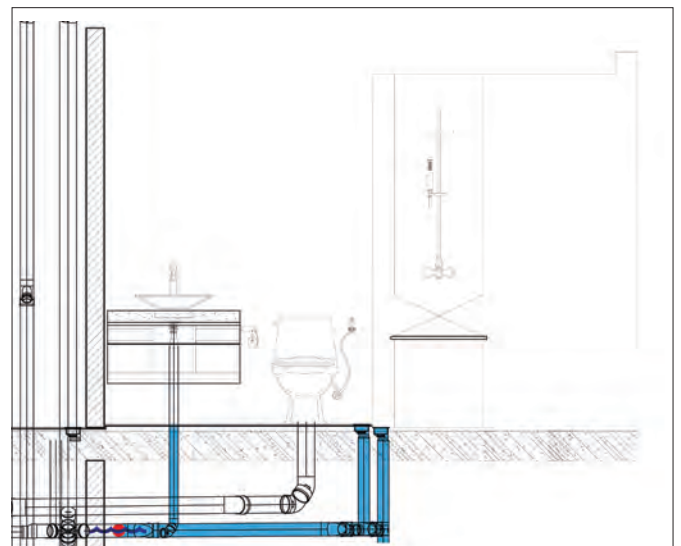

Illustration 7.26

Blockages between the stack and multiple sanitary appliances will always be subjected to the pressure originating from the lowest point of the system (in most cases, the blockage) and the exit point of the lowest sanitary appliance. The water height and pressure will be limited to the height of the lowest sanitary appliance.

Installation

In the stack

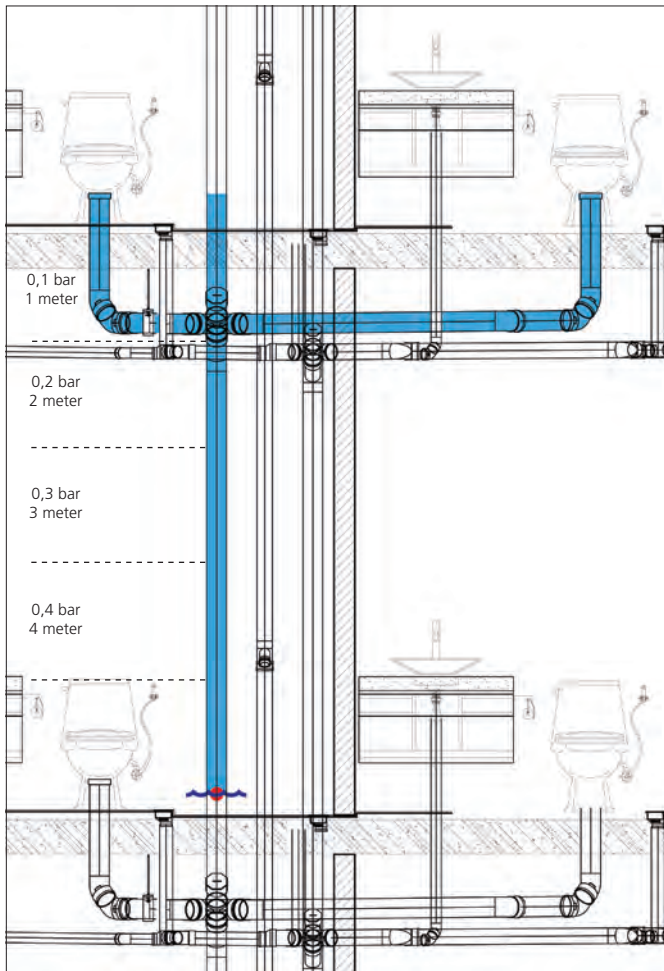

Illustration 7.27

A blockage in the stack is in the worst case located just before the horizontal connection to the floor below as in illustration 7.27. The maximum testing water head is determined by comparing the lowest possible point for a blockage and the lowest sanitary appliance on the floor above. In the example given in illustration 7.27 several pressures are given depending on the height of the water in relation to the blockage. Just above the point of blockage the water pressure will be relatively high compared to the water pressure in the horizontal part of the system before the exit point.

7.12.2 Test procedure

Before testing, precautions have to be taken to ensure that the test conducted delivers reliable results. Ensure that:

- All openings in the to be tested segment are closed. Caps above the testing floor do not have to be air tight.

! Testing floor is the floor where the pipe system is installed.

- Insert the test plug (displayed in illustration 7.28) from an access point and lower the test plug to the correct location. As previously defined in the methodology as described. Ensure that the test plug is inserted from at least 2 floors above the testing floor to ensure that the rope and air tube do not influence the test.
- Ensure that the test plug is placed correctly. For instance just above the highest stack branch at the testing floor. If the test plug is positioned too low, the water may find a way to escape resulting in a failed test.
- Fill stack with water until flood level is reached at floor above testing floor.
- Mark water level in the pipe or fitting at the point the system is filled.
- The pressure shall be maintained without leakage for 15 minutes. Ensure that the water level has not dropped more than 10mm.

! The source of any leak shall be ascertained and any defects shall be repaired. The section under test shall then be retested.



Illustration 7.28

Product range

8 Product range

8.1 Dimensions

The dimensions of the pipe and fittings in the product tables are all in mm unless stated differently. The standard wall thickness of the fittings is not included in the tables, but can be found in the table below.

Diameter d_1	Wall thickness e
40	1,8
50	1,8
75	2,3
90	2,8
110	3,4
125	3,9
160	4,9
200	6,2

Table 8.1

8.2 Abbreviations

Abbreviation	
DN_1	Nominal dimension
d_n / d_1	External dimension fitting/pipe
Z_1	Length until insertion point
α°	Angle of fitting
L	Total length fitting
l_1	Partial length of fitting

Table 8.2

Pipe with socket

PP-MD

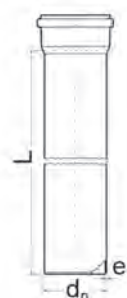

d_n	Code	L	e
40	PPA-040-018-015-D	150	1,8
40	PPA-040-018-025-D	250	1,8
40	PPA-040-018-050-D	500	1,8
40	PPA-040-018-100-A	1000	1,8
40	PPA-040-018-150-A	1500	1,8
40	PPA-040-018-200-A	2000	1,8
40	PPA-040-018-300-A	3000	1,8
50	PPA-050-018-015-D	150	1,8
50	PPA-050-018-025-D	250	1,8
50	PPA-050-018-050-D	500	1,8
50	PPA-050-018-100-A	1000	1,8
50	PPA-050-018-150-A	1500	1,8
50	PPA-050-018-200-A	2000	1,8
50	PPA-050-018-300-A	3000	1,8
75	PPA-075-023-015-D	150	2,3
75	PPA-075-023-025-D	250	2,3
75	PPA-075-023-050-D	500	2,3
75	PPA-075-023-100-A	1000	2,3
75	PPA-075-023-150-A	1500	2,3
75	PPA-075-023-200-A	2000	2,3
75	PPA-075-023-300-A	3000	2,3
90	PPA-090-028-015-D	150	2,8
90	PPA-090-028-025-D	250	2,8
90	PPA-090-028-050-D	500	2,8
90	PPA-090-028-100-A	1000	2,8
90	PPA-090-028-150-A	1500	2,8
90	PPA-090-028-200-A	2000	2,8
90	PPA-090-028-300-A	3000	2,8
110	PPA-110-034-015-D	150	3,4
110	PPA-110-034-025-D	250	3,4
110	PPA-110-034-050-D	500	3,4
110	PPA-110-034-100-A	1000	3,4
110	PPA-110-034-150-A	1500	3,4
110	PPA-110-034-200-A	2000	3,4
110	PPA-110-034-300-A	3000	3,4
125	PPA-125-039-015-D	150	3,9
125	PPA-125-039-025-D	250	3,9
125	PPA-125-039-050-D	500	3,9
125	PPA-125-039-100-A	1000	3,9
125	PPA-125-039-150-A	1500	3,9
125	PPA-125-039-200-A	2000	3,9
125	PPA-125-039-300-A	3000	3,9
160	PPA-160-049-015-D	150	4,9
160	PPA-160-049-025-D	250	4,9
160	PPA-160-049-050-A	500	4,9
160	PPA-160-049-100-A	1000	4,9
160	PPA-160-049-150-A	1500	4,9
160	PPA-160-049-200-A	2000	4,9
160	PPA-160-049-300-A	3000	4,9

Pipes

Pipe plain-end

PP-MD

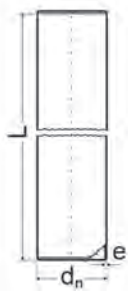

d_n	Code	L	e
200	PPA-200-062-300-A	3000	6,2

Double socket
with center stop

PP-MD



DN ₁	Code	L
40	VMD-040-000-00D	95
50	VMD-050-000-00D	100
75	VMD-075-000-00D	104
90	VMD-090-000-00D	111
110	VMD-110-000-00D	116
125	VMD-125-000-00D	120
160	VMD-160-000-00D	140
200	VMD-200-000-00D	217

Used for connecting pipe without socket.

Sleeve socket
without center stop

PP-MD

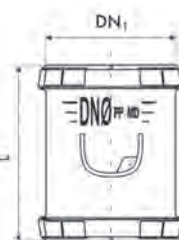

DN ₁	Code	L
40	VMP-040-000-00D	95
50	VMP-050-000-00D	97
75	VMP-075-000-00D	104
90	VMP-090-000-00D	111
110	VMP-110-000-00D	116
125	VMP-125-000-00D	120
160	VMP-160-000-00D	140
200	VMP-200-000-00D	217

Used for adding fittings to an existing pipe system, floor crossings or repairs.

Fittings

Reducer eccentric

PP-MD

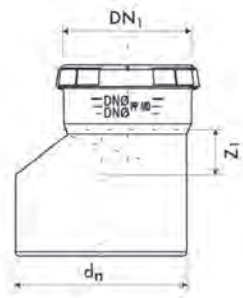

d_n/DN_1	Code	Z_1
50/40	VRD-050-040-00D	25
75/40	VRD-075-040-00D	25
75/50	VRD-075-050-00D	25
90/40	VRD-090-040-00D	40
90/50	VRD-090-050-00D	35
90/75	VRD-090-075-00D	24
110/50	VRD-110-050-00D	25
110/75	VRD-110-075-00D	25
110/90	VRD-110-090-00D	30
125/110	VRD-125-110-00D	30
160/110	VRD-160-110-00D	35
160/125	VRD-160-125-00D	35
200/160	VRD-200-160-00D	34

Elbow

15°/30°/45°/67°/87,5°

PP-MD

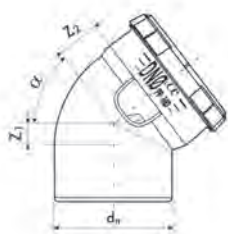

α°	d_n	Code	Z_1	Z_2
15	40	VKL-040-000-15D	4	12
15	50	VKL-050-000-15D	4	13
15	75	VKL-075-000-15D	12	16
15	90	VKL-090-000-15D	15	15
15	110	VKL-110-000-15D	14	18
30	40	VKL-040-000-30D	7	10
30	50	VKL-050-000-30D	8	12
30	75	VKL-075-000-30D	14	15
30	90	VKL-090-000-30D	20	19
30	110	VKL-110-000-30D	20	22
45	40	VKL-040-000-45D	12	18
45	50	VKL-050-000-45D	12	20
45	75	VKL-075-000-45D	20	28
45	90	VKL-090-000-45D	26	32
45	110	VKL-110-000-45D	25	35
45	125	VKL-125-000-45D	35	45
45	160	VKL-160-000-45D	38	60
45	200	VKL-200-000-45D	46	64
67	40	VKL-040-000-67D	16	20
67	50	VKL-050-000-67D	26	23
67	75	VKL-075-000-67D	30	31
67	90	VKL-090-000-67D	39	40
67	110	VKL-110-000-67D	45	44
87,5	40	VKL-040-000-90D	29	30
87,5	50	VKL-050-000-90D	33	35
87,5	75	VKL-075-000-90D	41	49
87,5	90	VKL-090-000-90D	54	59
87,5	110	VKL-110-000-90D	61	75
87,5	125	VKL-125-000-90D	75	78
87,5	160	VKL-160-000-90D	99	98
87,5	200	VKL-200-000-90D	105	122

Fittings

Swept bend
87,5°

PP-MD



α°	d_n	Code	L
87,5	50	VKL-050-LRB-90D ¹⁾	116
87,5	75	VKL-075-LRB-90D ¹⁾	130
87,5	90	VKL-090-LRB-90D ¹⁾	146
87,5	110	VKL-110-LRB-90D ¹⁾	161

¹⁾ fabricated

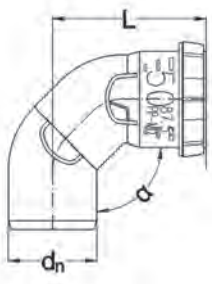

Branch
 45°/67°/87,5°

PP-MD

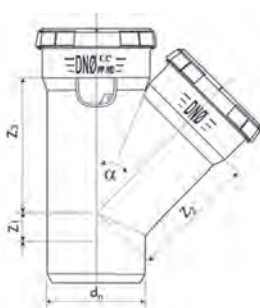

α°	d_n/DN_1	Code	Z_1	Z_2	Z_3
45	40/40	VTR-040-040-45D	15	54	54
45	50/40	VTR-050-040-45D	13	61	58
45	50/50	VTR-050-050-45D	17	67	67
45	75/40	VTR-075-040-45D	3	78	71
45	75/50	VTR-075-050-45D	1	83	81
45	75/75	VTR-075-075-45D	23	96	97
45	90/40	VTR-090-040-45D	12	88	83
45	90/50	VTR-090-050-45D	2	94	89
45	90/75	VTR-090-075-45D	16	106	106
45	90/90	VTR-090-090-45D	24	116	116
45	110/40	VTR-110-040-45D	19	100	90
45	110/50	VTR-110-050-45D	13	108	100
45	110/75	VTR-110-075-45D	4	120	118
45	110/90	VTR-110-090-45D	12	129	128
45	110/110	VTR-110-110-45D	29	140	140
45	125/110	VTR-125-110-45AD ¹⁾	23	162	162
45	125/125	VTR-125-125-45D	30	162	162
45	160/110	VTR-160-110-45D	5	184	190
45	160/160	VTR-160-160-45D	45	208	208
45	200/200	VTR-200-200-45D	46	244	244
67	40/40	VTR-040-040-67D	15	36	36
67	50/40	VTR-050-040-67D	13	44	41
67	50/50	VTR-050-050-67D	17	45	45
67	75/40	VTR-075-040-67D	8	58	48
67	75/50	VTR-075-050-67D	38	60	53
67	75/75	VTR-075-075-67D	38	65	65
67	90/40	VTR-090-040-67D	7	65	53
67	90/50	VTR-090-050-67D	10	68	59
67	90/90	VTR-090-090-67D	37	78	78
67	110/50	VTR-110-050-67D	12	77	63
67	110/75	VTR-110-075-67AD ¹⁾	20	87	80
67	110/110	VTR-110-110-67D	45	94	94
87,5	40/40	VTR-040-040-90D	30	29	29
87,5	50/40	VTR-050-040-90D	29	34	29
87,5	50/50	VTR-050-050-90D	33	34	35
87,5	75/40	VTR-075-040-90D	26	47	32
87,5	75/50	VTR-075-050-90D	32	47	36
87,5	75/75	VTR-075-075-90D	47	50	50
87,5	90/50	VTR-090-050-90D	40	58	53
87,5	90/75	VTR-090-075-90AD ¹⁾	27	55	40
87,5	90/90	VTR-090-090-90D	53	58	58
87,5	110/40	VTR-110-040-90D	27	63	36
87,5	110/50	VTR-110-050-90D	31	65	42
87,5	110/75	VTR-110-075-90D	44	66	55
87,5	110/90	VTR-110-090-90D	50	69	63
87,5	110/110	VTR-110-110-90D	62	70	70
87,5	125/110	VTR-125-110-90AD ¹⁾	60	80	75
87,5	125/125	VTR-125-125-90D	74	80	80
87,5	160/110	VTR-160-110-90AD ¹⁾	55	100	85
87,5	160/160	VTR-160-160-90D	108	101	101
87,5	200/200	VTR-200-200-90D	107	116	116

¹⁾ assembled

Fittings

Double branch
45°/67°/87,5°

PP-MD



α°	d_n/DN_1	Code
45	110/50	VCR-110-050-045
45	110/110	VCR-110-110-045
67	90/90	VCRZ-090-090-067 ¹⁾
67	110/50	VCRZ-110-050-067 ¹⁾
67	110/110	VCRZ-110-110-067 ¹⁾
87,5	110/110	VCRZ-110-110-090 ¹⁾

¹⁾ fabricated

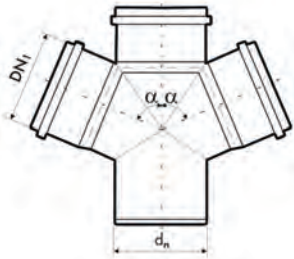

Double corner branch
67°/87,5°

PP-MD



α°	d_n/DN_1	Code
67	110/110	VCNZ-110-110-067 ¹⁾
87,5	110/110	VCNZ-110-110-090 ¹⁾

¹⁾ fabricated

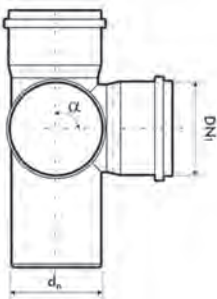

Clean out branch
90°

PP-MD

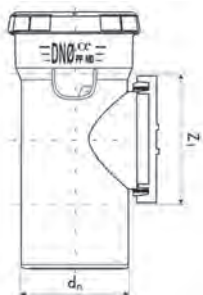

d_n	Code	Z_1
50	VCZ-050-000-00D	69
75	VCZ-075-000-00D	90
90	VCZ-090-000-00D	109
110	VCZ-110-000-00D	131
125	VCZ-125-000-00D	154
160	VCZ-160-000-00D	209
200	VCZ-200-000-00AD ¹⁾	223

¹⁾ assembled

Stack-aerator

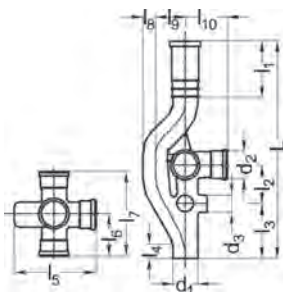

d_n	Code	L	l_1	l_2	l_3	l_4	l_5	l_6	l_7	l_8	l_9	l_{10}
110	VVEN-110-110-75D	956	256	170	240	60	344	159	318	55	130	159
160	VVEN-160-110-75D	1010	265	170	250	60	404	179	358	80	140	184

The dBlue stack-aerator is available with 6 possible horizontal branch connections that are closed with a cap. The sockets required for the horizontal connections need to be butt-welded on the stack-aerator. Specify configuration when ordering.

3 x d_2 : 110 mm
3 x d_3 : 75 mm

Opposite connections are not permitted.

Always use plug-in sockets for the horizontal connections and expansion sockets for the vertical connection on top.

d_1 , 75 mm - Art.Nr. VVEN-KIE-075-00D - dBlue plug-in socket (75 mm)
 d_1 , 110 mm - Art.Nr. VVEN-KIE-110-00D - dBlue plug-in socket (110 mm)
 d_1 , 110 mm - Art.Nr. VVEN-WLO-110-00D - dBlue expansion socket (110 mm)
 d_1 , 160 mm - Art.Nr. VVEN-WLO-160-00D - dBlue expansion socket (160 mm)

Inspection openings should be installed according to local regulation. We advise one on every level.

Fittings

Vent cowl

PP-MD



d_n	Code	d_1	L
50	WYW-050-000-000T	124	108
75	WYW-075-000-000T	124	108
110	WYW-110-000-000T	166	121
160	WYW-160-000-000T	223	151



Socket plug

PP-MD



d_n	Code	L
40	VKK-040-000-00D	32
50	VKK-050-000-00D	32
75	VKK-075-000-00D	33
90	VKK-090-000-00D	36
110	VKK-110-000-00D	37
125	VKK-125-000-00D	38
160	VKK-160-000-00D	40
200	VKK-200-000-00D	90

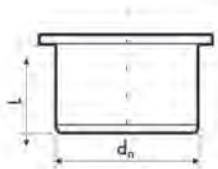

Fittings

Expansion socket

PP-MD



d_n	Code	L
75	VDK-075-000-00D	179
90	VDK-090-000-00D	193
110	VDK-110-000-00D	201

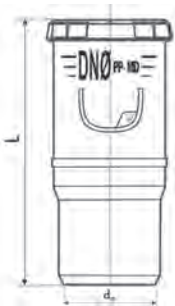

Floor waste gully

PP-MD



$d_1/d_2/d_3$	Code	L	I_1	I_2
110/50/75	VWP-110-050-75D	215	123	101

3 x 50 mm side inlets (factory closed)
 1 x 110 mm top inlet
 1 x 75 mm side outlet

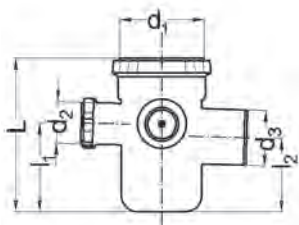

Four way riser

PP-MD



d_1/d_2	Code	L	L_1
110/50	VKO-110-050-00D	239	147

4 x 50 mm side inlets (factory closed)
 1 x 110 mm top inlet
 1 x 110 mm bottom outlet

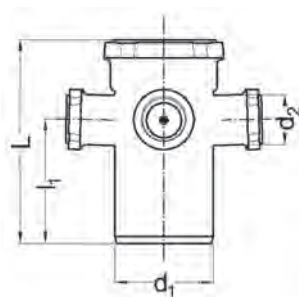

Traps

Adjustable disconnecter trap

PP-MD



d_1	Code	L	I_1
50	VSF-050-000-00D ¹⁾	100	123
75	VSF-075-000-00D ¹⁾	133	155
90	VSF-090-000-00D ¹⁾	160	176
110	VSF-110-000-00D ¹⁾	180	199

¹⁾ fabricated

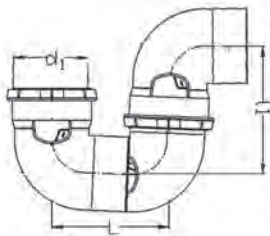

P-trap

PP



d_1	Code	L	I_1	I_2	I_3
110	VSFP-110-000-00D	235	134	61	206

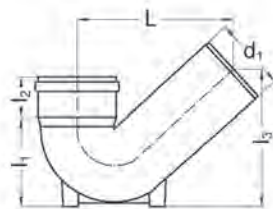

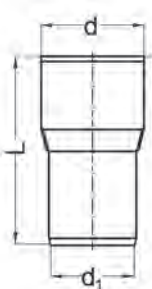
Cast iron transition

d_1/d	Code	L
50/58	TRA-050-000-000	120
75/78	TRA-075-000-000	125
110/110	TRA-110-000-000	140

PVC to dBlue transition

d_1/d	Code
36/40	TRA-PVC-036-040
43/50	TRA-PVC-043-050
56/75	TRA-PVC-056-075

Other materials to dBlue transition

d_1/d	Code
42/50	TRA-050-050-000
75/90	TRA-090-090-000
105/120	TRA-110-110-000

Rubber transitions are suitable to connect different diameter piping systems to dBlue pipes. dBlue transitions have a maximum testing pressure of 0,6 bar.

Fixing material

Socket securing clip



DN	Code	L	H
40	VCLP-KIE-STL-040	68	23
50	VCLP-KIE-STL-050	75	23
75	VCLP-KIE-STL-075	110	23
90	VCLP-KIE-STL-090	127	23
110	VCLP-KIE-STL-110	150	40
125	VCLP-KIE-STL-125	150	40
160	VCLP-KIE-STL-160	190	50
200	VCLP-KIE-STL-200	245	60

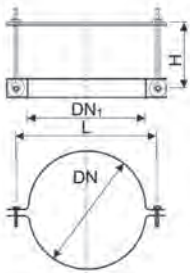

Socket retainer for testing



DN/DN ₁	Code	DN ₂	H	L ₁	L ₂
110/110	VDSC-KIE-STL-110	116	67	142	150
160/160	VDSC-KIE-STL-160	170	77	190	190

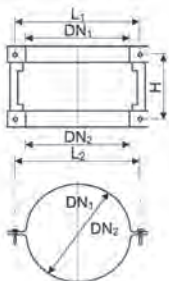

Bracket with rubber lining (metal)

Metal with rubber inlay



DN	Code
40	POB-STL-040-000
50	POB-STL-050-000
75	POB-STL-075-000
90	POB-STL-090-000
110	POB-STL-110-000
125	POB-STL-125-000
160	POB-STL-160-000
200	POB-STL-200-000

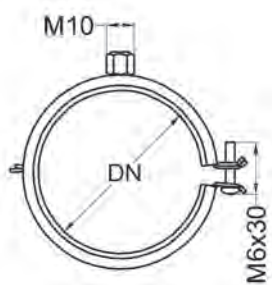

dBlue uses a single bracket type. The bracket is used as a guide bracket when installed with the 2 supplied spacers and as an anchor point bracket without spacers.

Tools & accessories

dBlue lubrication



Code	
250 ml	PAS-250-000-000

Pipe cutters



d	Code
40 - 75	NAR-OBC-040-075
50 - 125	NAR-OBC-050-125
90 - 160	NAR-OBC-090-160

Chamfer tool



d	Code
40 - 160	NAR-FAZ-040-160

Deburr tool



d	Code
40 - 200	NAR-OKR-040-200

Hole saw for floor gully and four way riser



d	Code
45 mm	NAR-KOR-045-200

Rubber ring

SBR



d	Code
40	USZ-KAN-040-BL
50	USZ-KAN-050-BL
75	USZ-KAN-075-BL
90	USZ-KAN-090-BL
110	USZ-KAN-110-BL
125	USZ-KAN-125-BL
160	USZ-KAN-160-BL
200	USZ-KAN-200-BL

Appendix A

Chemical resistance

The current state of knowledge about chemical resistance of plastics is based on long-lasting laboratory tests and practical experience. The following evaluation can be an initial indicator of the possibilities of Akatherm dBlue application for fluid transportation including transport at elevated temperatures. dBlue pipes and fittings and rubber gaskets are meant for transporting waste water ranging from acids (pH 2) to alkalis (pH 12) present in households. In case of industrial waste water, its chemical composition and concentration should be analyzed. The table covers a set of chemicals and determination of Akatherm dBlue chemical resistance. The following evaluation criteria were adopted:

Used symbols:

- + Resistant: in general Akatherm dBlue is a suitable material for this application
- / Limited resistance: further research necessary
- No resistance

Empty field No data available

Abbreviations:

- Sat. sol Saturated aqueous solution: prepared at 20°C
- Sol Aqueous solution at a concentration higher than 10% but not saturated

Component	Concentration	Temperature		
		20°C	60°C	100°C
Acetic acid	Up to 40%	+	+	
Acetic acid	50%	+	+	/
Acetic acid, glacial	>96%	+	/	-
Acetic anhydride	100%	+		
Acetone	100%	+	+	
Acrylonitrile	100%	+		
Allyl alcohol	100%	+	+	
Ammonia, aqueous	Sat. sol	+	+	
Ammonia, dry gas	100%	+		
Ammonia, liquid	100%	+		
Ammonium acetate	Sat. sol	+	+	
Ammonium chloride	Sat. sol	+	+	
Ammonium nitrate	Sat. sol	+	+	+
Ammonium sulphate	Sat. sol	+	+	+
Aniline	100%	+	+	
Beer		+	+	
Benzene	100%	/	-	-
Benzoic acid	Sat. sol	+	+	
Borax	Sol	+	+	
Boric acid	Sat. sol	+		
Bromine, liquid	100%	-	-	-
Butane, gas	100%	+		
Butanol	100%	+	/	/
Butyl acetate	100%	/	-	-
Calcium carbonate	Sat. sol	+	+	+
Calcium nitrate	Sat. sol	+	+	
Carbon dioxide, dry gas		+	+	
Chlorine, dry gas	100%	-	-	-
Chlorine, liquid	100%	-	-	-
Chloroform	100%	/	-	-
Chlorosulphonic acid	100%	-	-	-
Chromic acid	Up to 40%	+	/	-
Citric acid	Sat. sol	+	+	+
Copper (II) chloride	Sat. sol	+	+	
Cyclohexanone	100%	/	-	-

Appendix A

Component	Concentration	Temperature		
		20°C	60°C	100°C
Dextrin	Sol	+	+	
Dichloroethylene (A and B)	100%	/		
Dichloromethane	100%	/	-	
Ethanolamine	100%	+		
Ethyl alcohol	Up to 95%	+	+	+
Ethyl ether	100%	+	/	
Ethylene glycol	100%	+	+	+
Formaldehyde	40%	+		
Formic acid	10%	+	+	/
Gasoline, petrol (aliphatic hydrocarbons)		-	-	-
Glycerine	100%	+	+	+
Glycolic acid	30%	+		
Hexane	100%	+	/	
Hydrochloric acid	Up to 20%	+	+	+
Hydrochloric acid	30%	+	/	/
Hydrogen peroxide	Up to 30%	+	/	
Hydrogen sulphide, dry gas	100%	+	+	
Lactic acid	Up to 90%	+	+	
Magnesium chloride	Sat. sol	+	+	
Magnesium sulphate	Sat. sol	+	+	
Milk		+	+	+
Monochloroacetic acid	>85%	+	+	
Nitric acid	Up to 30%	+	-	-
Nitric acid	From 40 to 50%	/	-	-
Oleic acid	100%	+	/	
Oleum (sulphuric acid with 60% of +o3)		+	/	
Oxalic acid	Sat. sol	+	/	-
Oxygen, gas		+		
Phenol	90%	+		
Potassium bromate	Up to 10%	+	+	
Potassium chlorate	Sat. sol	+	+	
Potassium chromate	Sat. sol	+	+	
Potassium cyanide	Sol	+		
Potassium dichromate	Sat. sol	+	+	+
Potassium ferricyanide	Sat. sol	+	+	
Potassium hydroxide	Up to 50%	+	+	+
Potassium nitrate	Sat. sol	+	+	
Potassium permanganate	(2 N) 30%	+		
Propane, gas	100%	+		
Pyridine	100%	/		
Seawater		+	+	+
Sodium chlorate	Sat. sol	+	+	
Sodium hydroxide	From 10 to 60%	+	+	+
Sodium hypochlorite	From 10 to 15%	+		
Sodium sulphite	40%	+	+	+
Sulphuric acid	Up to 10%	+	+	+
Sulphuric dioxide, dry or wet	100%	+	+	
Tartaric acid	Sat. sol	+	+	
Tin (IV) chloride	Sol	+	+	
Tin (II) chloride	Sat. sol	+	+	
Toluene	100%	/	-	-
Trichloroethylene	100%	-	-	-
Urea	Sat. sol	+	+	
Vinegar		+	+	
Wines		+	+	
Xylene	100%	-	-	-

Index

A

Acoustic brackets.....	55
Adjustable disconnecter trap.....	52

B

Bracket with rubber lining (metal).....	55
Branches.....	45

C

Cast iron transition.....	53
Chamfer tool.....	56
Clean out branch.....	47

D

dBlue lubrication.....	56
Deburr tool.....	57
Double branch.....	46
Double corner branch.....	46
Double socket.....	41

E

Elbows.....	43
Expansion socket.....	50
Expansion sockets.....	50

F

Floor waste gully.....	51
Four way riser.....	51

H

Hole saw for floor gully and four way riser.....	57
--	----

O

Other materials to dBlue transition.....	53
--	----

P

Pipe cutters.....	56
Pipe plain-end.....	40
Pipes.....	39
Pipe with socket.....	39
P-trap.....	52
PVC to dBlue transition.....	53

R

Reducer eccentric.....	42
Reducers.....	42
Rubber ring.....	57

S

Sleeve socket.....	41
Socket plug.....	49

Socket plugs.....	49
Socket retainer for testing.....	54
Sockets.....	41
Socket securing clip.....	54
Stack-aerator.....	47
Swept bend.....	44

T

Tools & accessories.....	56
Transition fittings.....	53
Traps.....	51

V

Vent cowl.....	48
----------------	----

Code	Page	Code	Page	Code	Page
NAR-FAZ-040-160	56	TRA-110-000-000	53	VKL-090-000-67D	43
NAR-KOR-045-200	57	TRA-110-110-000	53	VKL-090-000-90D	43
NAR-OBC-040-075	56	TRA-PVC-036-040	53	VKL-090-LRB-90D	44
NAR-OBC-050-125	56	TRA-PVC-043-050	53	VKL-110-000-15D	43
NAR-OBC-090-160	56	TRA-PVC-056-075	53	VKL-110-000-30D	43
NAR-OKR-040-200	57	USZ-KAN-040-BL	57	VKL-110-000-45D	43
PAS-250-000-000	56	USZ-KAN-050-BL	57	VKL-110-000-67D	43
POB-STL-040-000	55	USZ-KAN-075-BL	57	VKL-110-000-90D	43
POB-STL-050-000	55	USZ-KAN-090-BL	57	VKL-110-LRB-90D	44
POB-STL-075-000	55	USZ-KAN-110-BL	57	VKL-125-000-45D	43
POB-STL-090-000	55	USZ-KAN-125-BL	57	VKL-125-000-90D	43
POB-STL-110-000	55	USZ-KAN-160-BL	57	VKL-160-000-45D	43
POB-STL-125-000	55	USZ-KAN-200-BL	57	VKL-160-000-90D	43
POB-STL-160-000	55	VCLP-KIE-STL-040	54	VKL-200-000-45D	43
POB-STL-200-000	55	VCLP-KIE-STL-050	54	VKL-200-000-90D	43
PPA-040-018-015-D	39	VCLP-KIE-STL-075	54	VKO-110-050-00D	51
PPA-040-018-025-D	39	VCLP-KIE-STL-090	54	VMD-040-000-00D	41
PPA-040-018-050-D	39	VCLP-KIE-STL-110	54	VMD-050-000-00D	41
PPA-040-018-100-A	39	VCLP-KIE-STL-125	54	VMD-075-000-00D	41
PPA-040-018-150-A	39	VCLP-KIE-STL-160	54	VMD-090-000-00D	41
PPA-040-018-200-A	39	VCLP-KIE-STL-200	54	VMD-110-000-00D	41
PPA-040-018-300-A	39	VCNZ-110-110-067	46	VMD-125-000-00D	41
PPA-050-018-015-D	39	VCNZ-110-110-090	46	VMD-160-000-00D	41
PPA-050-018-025-D	39	VCR-110-050-045	46	VMD-200-000-00D	41
PPA-050-018-050-D	39	VCR-110-110-045	46	VMP-040-000-00D	41
PPA-050-018-100-A	39	VCRZ-090-090-067	46	VMP-050-000-00D	41
PPA-050-018-150-A	39	VCRZ-110-050-067	46	VMP-075-000-00D	41
PPA-050-018-200-A	39	VCRZ-110-110-067	46	VMP-090-000-00D	41
PPA-050-018-300-A	39	VCRZ-110-110-090	46	VMP-110-000-00D	41
PPA-075-023-015-D	39	VCZ-050-000-00D	47	VMP-125-000-00D	41
PPA-075-023-025-D	39	VCZ-075-000-00D	47	VMP-160-000-00D	41
PPA-075-023-050-D	39	VCZ-090-000-00D	47	VMP-200-000-00D	41
PPA-075-023-100-A	39	VCZ-110-000-00D	47	VRD-050-040-00D	42
PPA-075-023-150-A	39	VCZ-125-000-00D	47	VRD-075-040-00D	42
PPA-075-023-200-A	39	VCZ-160-000-00D	47	VRD-075-050-00D	42
PPA-075-023-300-A	39	VCZ-200-000-00AD	47	VRD-090-040-00D	42
PPA-090-028-015-D	39	VDK-075-000-00D	50	VRD-090-050-00D	42
PPA-090-028-025-D	39	VDK-090-000-00D	50	VRD-090-075-00D	42
PPA-090-028-050-D	39	VDK-110-000-00D	50	VRD-110-050-00D	42
PPA-090-028-100-A	39	VDSC-KIE-STL-110	54	VRD-110-075-00D	42
PPA-090-028-150-A	39	VDSC-KIE-STL-160	54	VRD-110-090-00D	42
PPA-090-028-200-A	39	VKK-040-000-00D	49	VRD-125-110-00D	42
PPA-090-028-300-A	39	VKK-050-000-00D	49	VRD-160-110-00D	42
PPA-110-034-015-D	39	VKK-075-000-00D	49	VRD-160-125-00D	42
PPA-110-034-025-D	39	VKK-090-000-00D	49	VRD-200-160-00D	42
PPA-110-034-050-D	39	VKK-110-000-00D	49	VSF-050-000-00D	52
PPA-110-034-100-A	39	VKK-125-000-00D	49	VSF-075-000-00D	52
PPA-110-034-150-A	39	VKK-160-000-00D	49	VSF-090-000-00D	52
PPA-110-034-200-A	39	VKK-200-000-00D	49	VSF-110-000-00D	52
PPA-110-034-300-A	39	VKL-040-000-15D	43	VSF-110-000-00D	52
PPA-125-039-015-D	39	VKL-040-000-30D	43	VTR-040-040-45D	45
PPA-125-039-025-D	39	VKL-040-000-45D	43	VTR-040-040-67D	45
PPA-125-039-050-D	39	VKL-040-000-67D	43	VTR-040-040-90D	45
PPA-125-039-100-A	39	VKL-040-000-90D	43	VTR-050-040-45D	45
PPA-125-039-150-A	39	VKL-050-000-15D	43	VTR-050-040-67D	45
PPA-125-039-200-A	39	VKL-050-000-30D	43	VTR-050-040-90D	45
PPA-125-039-300-A	39	VKL-050-000-45D	43	VTR-050-050-45D	45
PPA-160-049-015-D	39	VKL-050-000-67D	43	VTR-050-050-67D	45
PPA-160-049-025-D	39	VKL-050-000-90D	43	VTR-050-050-90D	45
PPA-160-049-050-A	39	VKL-050-LRB-90D	44	VTR-075-040-45D	45
PPA-160-049-100-A	39	VKL-075-000-15D	43	VTR-075-040-67D	45
PPA-160-049-150-A	39	VKL-075-000-30D	43	VTR-075-040-90D	45
PPA-160-049-200-A	39	VKL-075-000-45D	43	VTR-075-050-45D	45
PPA-160-049-300-A	39	VKL-075-000-67D	43	VTR-075-050-67D	45
PPA-200-062-300-A	40	VKL-075-000-90D	43	VTR-075-050-90D	45
TRA-050-000-000	53	VKL-075-LRB-90D	44	VTR-075-075-45D	45
TRA-050-050-000	53	VKL-090-000-15D	43	VTR-075-075-67D	45
TRA-075-000-000	53	VKL-090-000-30D	43	VTR-075-075-90D	45
TRA-090-090-000	53	VKL-090-000-45D	43	VTR-090-040-45D	45

Articlelist

Code	Page
VTR-090-040-67D.....	45
VTR-090-050-45D.....	45
VTR-090-050-67D.....	45
VTR-090-050-90D.....	45
VTR-090-075-45D.....	45
VTR-090-075-90AD.....	45
VTR-090-090-45D.....	45
VTR-090-090-67D.....	45
VTR-090-090-90D.....	45
VTR-110-040-45D.....	45
VTR-110-040-90D.....	45
VTR-110-050-45D.....	45
VTR-110-050-67D.....	45
VTR-110-050-90D.....	45
VTR-110-075-45D.....	45
VTR-110-075-67AD.....	45
VTR-110-075-90D.....	45
VTR-110-090-45D.....	45
VTR-110-090-90D.....	45
VTR-110-110-45D.....	45
VTR-110-110-67D.....	45
VTR-110-110-90D.....	45
VTR-125-110-45AD.....	45
VTR-125-110-90AD.....	45
VTR-125-125-45D.....	45
VTR-125-125-90D.....	45
VTR-160-110-45D.....	45
VTR-160-110-90AD.....	45
VTR-160-160-45D.....	45
VTR-160-160-90D.....	45
VTR-200-200-45D.....	45
VTR-200-200-90D.....	45
VVEN-110-110-75D.....	47
VVEN-160-110-75D.....	47
VWP-110-050-75D.....	51
WYW-050-000-000T.....	48
WYW-075-000-000T.....	48
WYW-110-000-000T.....	48
WYW-160-000-000T.....	48

Notes section containing 20 horizontal grey bars for writing.

Notes

A series of 18 horizontal grey bars providing a space for handwritten notes.